

**IB-ER**®  
**PROSTHETIC**



PRODUCT  
CATALOGUE  
**2026**

[www.ib-er.com](http://www.ib-er.com)  
[info@ib-er.com](mailto:info@ib-er.com)



**PROSTHETIC**

*make your life easier*

www.ib-er.com  
info@ib-er.com

## **Welcome to IB-ER Prosthetics — Your Global Partner in Advanced Prosthetic and Orthotic Solutions**

For over 38 years, IB-ER Prosthetics has been a family-owned manufacturer delivering high-quality prosthetic and orthotic solutions. Driven by craftsmanship, innovation, and precision engineering, we have built a trusted position in the global medical device industry.

Quality and compliance define our operations. We operate under certified quality management systems, including ISO 13485 and ISO 9001, with products developed in full alignment with EU Standards. Our processes are supported by CE certification, robust documentation, traceability, and Medical Device (MD) registration in accordance with regulatory requirements.

Today, IB-ER Prosthetics serves partners in more than 80 countries, supporting clinicians, distributors, and healthcare providers who demand reliability, safety, and performance. Our international footprint reflects both our manufacturing capabilities and the confidence of our partners worldwide.

We recognize that every device supports an individual's mobility and independence. Our team continuously develops solutions that combine functionality, comfort, durability, and contemporary design to deliver consistent, high-performance outcomes.

At IB-ER Prosthetics, we go beyond manufacturing—we provide long-term partnership, regulatory assurance, and responsive support to help our partners grow and succeed.

We invite you to explore our catalogue and discover the precision, reliability, and global expertise that define IB-ER Prosthetics.

Vural ERYILMAZ  
Production Manager

Erol ERYILMAZ  
General Manager





## Quality, Compliance and Trust



Our operations are governed by internationally recognized quality and regulatory standards. We are certified to ISO 9001 and ISO 13485, reflecting our commitment to consistent quality management and medical device excellence. Our products carry CE marking and are supported by a Certificate of Free Sale, confirming their compliance and market readiness. In addition, we fully comply with the Medical Device Regulation (MDR), ensuring safety, performance, and regulatory integrity across all stages—from design and manufacturing to distribution.

Page

<b>7</b>	<b>Carbon Foot And Foot Shell</b>
<b>8</b>	Winged Foot
<b>10</b>	Supreme Foot
<b>11</b>	VACX Foot
<b>12</b>	AbsorbX Foot
<b>13</b>	Swipe Foot
<b>14</b>	Short Foot
<b>15</b>	Symes Foot
<b>16</b>	FM-Foot
<b>17</b>	Foot Shell
<b>19</b>	Overall Look of Carbon Foot Family
<b>20</b>	<b>Prosthetic Foot &amp; Modular Adapters</b>
<b>21</b>	Sach Foot
<b>22</b>	Sach Foot and Dynamic Foot Adapter
<b>23</b>	Single Axis Foot And Adapters
<b>24</b>	Pyramid Receivers
<b>26</b>	Pyramid Adapters
<b>29</b>	Sliding & Rotating Socket Adapters
<b>30</b>	Sliding Adapters
<b>31</b>	Tube Assembly
<b>32</b>	Aluminum Tubes
<b>33</b>	Tube Clamp Adapters
<b>35</b>	Lamination Anchors
<b>40</b>	Double Adapters with Adjustment Screws
<b>41</b>	Double Adapter
<b>42</b>	Attachment Blocks
<b>43</b>	Lamination & Offset Plates
<b>44</b>	<b>Knee Joints</b>
<b>45</b>	Polycentric Knee Joint
<b>46</b>	Pneumatic Knee Joints
<b>47</b>	Monocentric Knee Joint with Rotary Hydraulics
<b>48</b>	Aluminum Knee Joints
<b>50</b>	Rotation Adapter
<b>51</b>	Aluminum Locking Knee Joints
<b>52</b>	Titanium and Steel Knee Joints
<b>53</b>	Disarticulation Knee Joints and Hip Joints
<b>55</b>	<b>Silicone &amp; Gel Liners</b>
<b>56</b>	Silicone Liners
<b>58</b>	Performance Silicone Liners
<b>59</b>	Gel Liners
<b>60</b>	Suspension Sleeves
<b>61</b>	<b>Lock Systems &amp; Valves</b>
<b>62</b>	Clutch Locks
<b>64</b>	Shuttle Locks
<b>65</b>	Active Vacuum Unit
<b>66</b>	Valves
<b>68</b>	<b>Components for Children</b>
<b>72</b>	<b>Foam Covers</b>
<b>75</b>	<b>Materials</b>
<b>84</b>	<b>Upper Limb Components</b>
<b>89</b>	<b>Orthotic Components</b>



As an important point in prostheses, we define our symbols and their meanings clearly to assist you to choose correct product for the users. Here you can find our terminology in this section.



K1: Defines a user takes indoor-walks, who mostly walks in the home or on flat surfaces with fixed cadence.



K2: Defines a user who has the ability to overcome low level environmental barriers such as curbs, stairs or uneven surfaces.



K3: Defines a user who has the ability or potential of ambulation with variable walking speeds, who overcomes almost all of the environmental barriers.



K4: Defines a user who exceeds basic ambulation skills daily, with the highly variable walking speeds. This user performs activities which causes high impacts and stress on the prostheses.



Waterproof products have been specially produced to resist the corrosive situations like showering and swimming. These products can withstand the fresh water and salt water with the little care. These products have special water-drain channels to discharge the water smoothly once they've been used. It should be noted that, after each use in salt water, the prosthesis must be rinsed with fresh water and dried afterwards properly.



Products with "Forged Titanium" label has been produced via Hot forging technology which increases toughness and durability of the product significantly.



All of our Aluminum products you see with this label on, consisting a pyramid have been built with Titanium Pyramid instead of Steel.



Winged Foot

## Carbon Foot



Supreme Foot



VACX Foot



AbsorbX Foot



Swipe Foot



Short Foot



Symes Foot



FM-Foot



## Winged Foot

### Introduction

Winged foot is designed as a multi-functional foot with complete carbon fiber structure. It has two main plates, divided in two parts which allows +/- 10 degrees of inversion and eversion movements of the carbon foot. Also split main plate design of the foot provides +/- 5 degrees of the torsion of the pyramid section. For smoother gait cycle, there is an additional inner carbon plate to comfort during the stance phase, causing the main plate to flex till a particular point easily and prevents further loads.

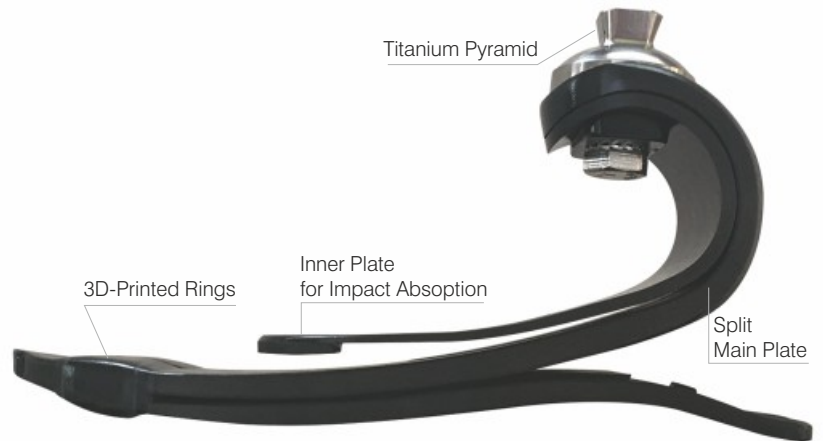

### 3D-Printed rings together with carbon fibers

3D-Printed rings allows easily seat and cover for carbon fibers as well as reduces and distributes the stress of heel strike force by its pre-shaped structure and round corners.



### Features

- +/- 5 degrees Torsion of Pyramid
  - +/- 10 degrees of Inversion and Eversion
  - Multi-axial body
  - Impact absorption by inner Plate
- Wide body with to increase ground stability

**±10** degrees  
**Eversion and Inversion!**



Thanks to its split lines on main plate, pyramid section of the foot easily rotates around center of the pyramid and causes +/- 5 degrees of torsion.

**±5 degrees**  
**Torsion of Pyramid**

Technical Information

Target Users: Moderate impact, K3-K4 level patients

Stiffness Categories: 1 to 5

Connector Type: Titanium Male Pyramid

Max. Body weight: 120 kg

Size range: 23 to 29

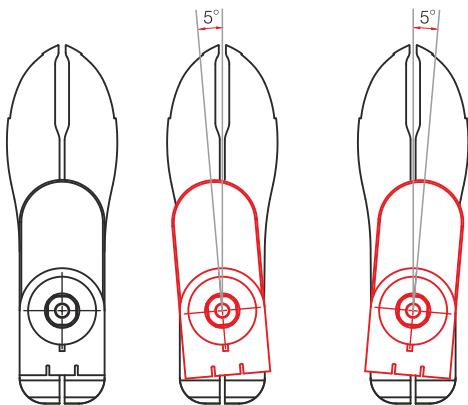

Category Selection

Body Weight	Category
65- 75 kg	CAT-1
75- 85 kg	CAT-2
85- 95 kg	CAT-3
95- 105 kg	CAT-4
105- 120 kg	CAT-5

Impact Absorption

When load is placed on the toe, main carbon plate twists through C-shaped inner carbon plate. In this case, inner plate behaves like a shock absorber and shares the impact force with main plate.

This movement also supports energy return to toe-off phase.

Data Table

Product Name	Winged Foot
Sizes	23 to 29
Advised Activity Level	K3-K4
Max User Weight	120 Kg
Mean Product Length	110 mm
Mean Product Weight	390 Gr
Available Foot Shell Color	Beige & Brown

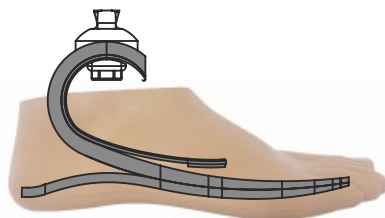
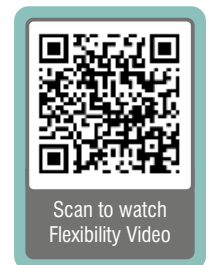

Order Example

**W27-CAT3**  
| | |  
Winged Size Category  
Foot





**Supreme**  
The Carbon Foot

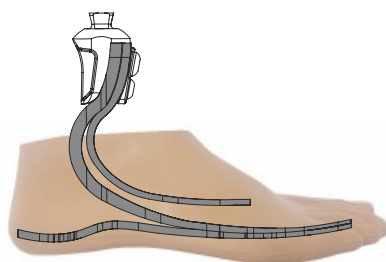

- Foot Shell is same for all foot types and available in all sizes.
- Foot Shell should be ordered separately by its size and colour. Please see page 17.

## Supreme Foot

### Features

- Totally carbon fiber body provides high energy return and smooth gait cycle.
- Additional inner carbon plate “Absorbs” surplus energy and increases life span of the product.
- “3D-Printed Rings Technology” (Patent Pending) provides “Screw-less” connection of carbon plates at toe section. This provides smooth feeling and gait cycle for the user.
- Pyramid of the product is made by Titanium, lightweight and durable against set-screw pressure.
- Suitable for K3-K4 level users.



### Category Selection

Body Weight	Category
65-75 kg	CAT-1
75-85 kg	CAT-2
85-95 kg	CAT-3
95-105 kg	CAT-4
105- 120 kg	CAT-5

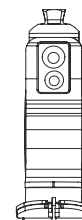
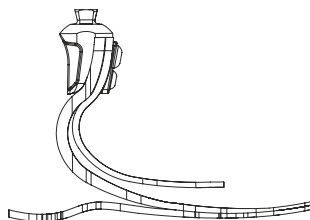

### Data Table

Product Name	Supreme Foot
Sizes	24 to 28
Advised Activity Level	K3-K4
Max User Weight	120 Kg
Mean Product Length	150 mm
Mean Product Weight	480 Gr
Available Foot Shell Color	Beige & Brown

### Order Example

**Supreme28 -CAT2**

Supreme Foot Size | Category



Scan to watch  
Flexibility Video



**VACX**  
OF THE WINGED FOOT

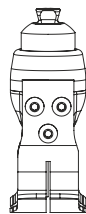
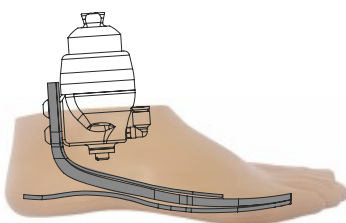

VAC series comes with the Standard Connector. It's also possible to order DSC-Valve, which has a push-button feature to release the vacuum.



Standard Connector



DSC-Valve

- VACX Foot should be used together with low height Foot Shell, please check through the Foot Shell section at the end of the Carbon feet range.
- Foot Shell should be ordered separately.

## VACX Foot

### Features

- VACX is a carbon fiber foot which has been developed based on the Winged Foot Structure.
- "Active Vacuum Unit" of the VAC-100 product has been placed on the Winged Foot to generate an elevated vacuum inside of the socket.
- Generated vacuum occurs between user's liner and the socket to prevent pistoning movement and grip the stump firmly.
- This system cancels out the need of using locks and silicone liners with the pin system.
- Absorbs high reaction forces of the ground and creates vacuum on each step.
- Totally Multi-axial body, allows 10 degrees of Inversion & Eversion



### Vacuumping the Socket

The socket should be sealed with sleeves to create vacuum-able environment inside. Once the environment is sealed, which is compressed and released during the walking, the vacuum unit draws air from the socket through the one-way valve and evacuates it through the pump. After multiple steps of the user, 15 in. Hg (around 0.5 bar) vacuum is created in the sealed socket

### Category Selection

Body Weight	Category
65- 75 kg	CAT-1
75- 85 kg	CAT-2
85- 95 kg	CAT-3
95- 105 kg	CAT-4
105-120 kg	CAT-5



### Data Table

Product Name	VACX Foot
Sizes	23 to 28
Advised Activity Level	K3-K4
Max User Weight	120 Kg
Mean Product Length	160 mm
Mean Product Weight	740 Gr

### Order Example

**VAC26-CAT2**  
VACX Foot Size      Category



Scan to watch Flexibility Video



## AbsorbX Foot

### Features

- AbsorbX Foot is a carbon fiber foot which has been developed based on the Winged Foot Structure.
- This carbon foot provides the user with a smooth and comfortable gait cycle.
- Shock absorption up to 8 mm!
- It absorbs the high reaction forces of the ground and creates a cushioning feeling with every step.
- Totally Multi-axial body, allows 10 degrees of Inversion & Eversion.



### Category Selection

Body Weight	Category
65-75 kg	CAT-1
75-85 kg	CAT-2
85-95 kg	CAT-3
95-105 kg	CAT-4
105-120 kg	CAT-5

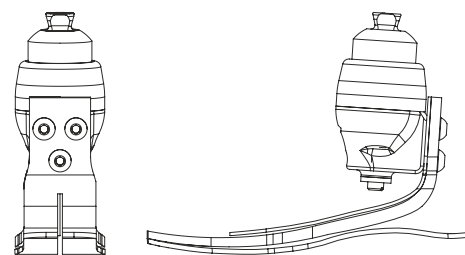

# Absorb **X**

OF THE WINGED FOOT

### Shock Absorption

Ground reaction forces have a special head adapter structure that absorbs. The foot's multi-axial body design is another noteworthy aspect, allowing for up to 10 degrees of inversion and eversion. This dynamic range of motion enables the foot to better adapt to uneven terrain and changes in walking conditions, providing enhanced stability and balance for the user.

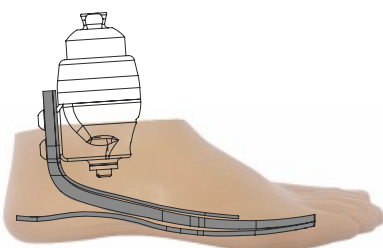

### Data Table

Product Name	AbsorbX Foot
Sizes	23 to 28
Advised Activity Level	K3-K4
Max User Weight	120 Kg
Mean Product Length	160 mm
Mean Product Weight	740 Gr

### Order Example

**ABS26 - CAT2**  
 | | |  
 AbsorbX Foot Size Category



Scan to watch  
Flexibility Video

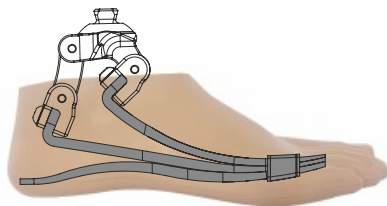

- Swipe Foot should be used together with low height Foot Shell, please check through the Foot Shell section at the end of the Carbon feet range.
- Foot Shell should be ordered separately.

## Swipe Foot

### Features

- Swipe Foot is a unique carbon foot with a polycentric ankle design.
- Provides superior dorsiflexion and plantar flexion movements on each step.
- Each blade of the feet contributes through stance phase by flexing to a point by center of rotation of the polycentric design.
- Generates further toe-off energy for smooth and effort-free steps.
- Suitable for K3-K4 level users.



### Category Selection

Body Weight	Category
65- 75 kg	CAT-1
75- 85 kg	CAT-2
85- 95 kg	CAT-3
95- 105 kg	CAT-4

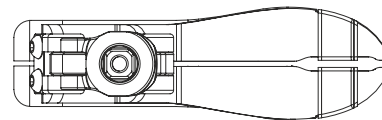
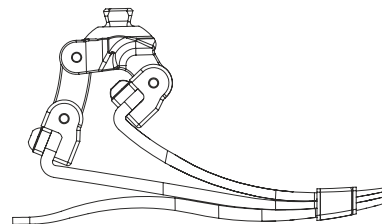

### Data Table

Product Name	Swipe Foot
Sizes	24 to 28
Advised Activity Level	K3-K4
Max User Weight	105 Kg
Mean Product Length	120 mm
Mean Product Weight	550 Gr

### Order Example

**SW26-CAT2**

Swipe Foot Size | Category



Scan to watch Flexibility Video



**Short**  
*The Carbon Foot*

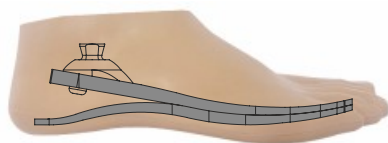

- Foot Shell is same for all foot types and available in all sizes.
- Foot Shell should be ordered separately by its size and colour. Please see the pages 17 and 18.

## Short Foot

### Features

- As seen by it's name, Short profile design is suitable for users with long residual limbs.
- Even having a Short profile, the foot provides energy return which is considerably high.
- Short height structure enables to use additional components on top, such as active vacuum adapters and shock absorbers.
- "3D-Printed Rings Technology" (Patent Pending) provides "Screw-less" connection of carbon plates at toe section. This provides smooth feeling and gait cycle for the user.
- Suitable for K2-K3 level users.



### Category Selection

Body Weight	Category
65- 75 kg	CAT-1
75- 85 kg	CAT-2
85- 95 kg	CAT-3
95- 105 kg	CAT-4
105- 120 kg	CAT-5

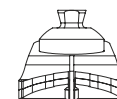

### Data Table

Product Name	Short Foot
Sizes	23 to 29
Advised Activity Level	K2-K3
Max User Weight	120 Kg
Mean Product Length	50 mm
Mean Product Weight	350 Gr
Available Foot Shell Color	Beige & Brown

### Order Example

**Short26-CAT2**

Short Foot | Size | Category



Scan to watch  
Flexibility Video



## Symes Foot

### Features

- As seen by its name, this foot mostly focuses on users with Symes amputation.
- Symes foot has stable M36 Thread and 4-Prong Socket Adapter to be connected with the socket directly.
- Symes foot has the same flexible carbon structure with the Short Foot, provides high energy return and smooth gait cycle.
- “3D-Printed Rings Technology” has been used, as well as other carbon fiber foots in the product range.



### Category Selection

Body Weight	Category
65- 75 kg	CAT-1
75- 85 kg	CAT-2
85- 95 kg	CAT-3
95- 105 kg	CAT-4
105- 120 kg	CAT-5

## **SYMES FOOT** “Fixed Socket Adapter!”

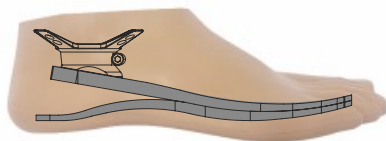
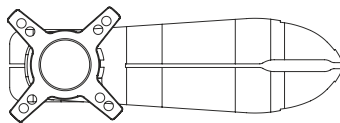
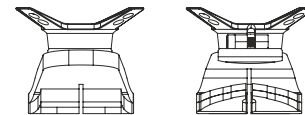

### Data Table

Product Name	Symes Foot
Sizes	23 to 29
Advised Activity Level	K2-K3
Max User Weight	120 Kg
Mean Product Length	50 mm
Mean Product Weight	420 Gr
Available Foot Shell Color	Beige & Brown

- Foot Shell is same for all foot types and available in all sizes.
- Foot Shell should be ordered separately by its size and colour. Please see the pages 17 and 18.

### Order Example

**Symes26-CAT2**

Symes Foot | Size | Category



Scan to watch Flexibility Video



## FM-Foot

### Features

- FM-Foot provides smooth gait and cushion feeling to the low and moderate mobility level users.
- FM-Foot has Aluminum adapter, which is lightweight and durable.
- Split-toe design allows the foot to adapt on uneven surfaces.
- PU based heel section, provides damping and cushion.
- Plate of the FM-Foot is made by Carbon Fiber.
- FM-Foot has been updated to have 120 Kg user weight for all sizes.



## FM-FOOT

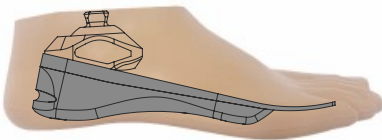
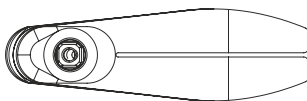

- FM-Foot is compatible with both Standard Profile (AS) and Low Profile Foot Shells (LAS). It's noted that Low Profile Shells (LAS) series are more convenient to use with FM-Foot.
- Foot Shell is same for all foot types and available in all sizes.
- Foot Shell should be ordered separately by its size and color. Please see page 17 and 18.
- To assemble the FM Foot with the Foot Shell properly, a Foot Shell Tool is required. It's important to match the teeth (which is on posterior on feet) of Foot Shell and FM Foot properly while assembling them. Please see page 17 and 18.

### Data Table

Product Name	FM-Foot
Sizes	23 to 29
Advised Activity Level	K2
Mean Product Length	70 mm
Mean Product Weight	310 Gr
Available Foot Shell Color	Beige & Brown

### Order Example

**FM26**

FM-Foot Size



Scan to watch  
Flexibility Video



AS-26R



Connection Cap

### Foot Shell - Standard Height

- Specially produced by Thermoplastic Rubber (TPR)
- Suitable for all type of IB-ER Prosthetic feet.
- 60 Shore hardness.
- Two different color options (Beige and Brown).
- Standard Height Foot Shells comes with its connection cap!

Code	Foot Size	Heel Height	Color	Side
AS-23L/R	23	10mm	Beige	L/R
AS-24L/R	24	10mm	Beige	L/R
AS-25L/R	25	10mm	Beige	L/R
AS-26L/R	26	10mm	Beige	L/R
AS-27L/R	27	10mm	Beige	L/R
AS-28L/R	28	10mm	Beige	L/R
AS-29L/R	29	10mm	Beige	L/R

Code	Foot Size	Heel Height	Color	Side
AB-23L/R	23	10mm	Brown	L/R
AB-24L/R	24	10mm	Brown	L/R
AB-25L/R	25	10mm	Brown	L/R
AB-26L/R	26	10mm	Brown	L/R
AB-27L/R	27	10mm	Brown	L/R
AB-28L/R	28	10mm	Brown	L/R
AB-29L/R	29	10mm	Brown	L/R

### Order Example

**AS-26-LEFT**  
 Beige Color | Size | Foot Shell Type

**AB-26-RIGHT**  
 Brown Color | Size | Foot Shell Type

### Accessory



Foot Shell Tool ( FST )

### Foot Shell Removal Tool

- A tool for removing the foot from the foot shell.
- Works with all kind of carbon feet.
- One end is a hook type bent and the other end is a flat for applying a force.
- Made by stainless steel for durability and to avoid corrosion in long term.

Code	Material
FST	Stainless Steel



Spectra Sock

### Spectra Sock

- Spectra Sock made by special Fiber Glass material.
- High wear resistance.
- Suitable for all kind of carbon feet.

Code	Material	Color
S-CF	Fiber Glass	White



LAS-26R

## Foot Shell - Low Height

- Contains all material specs of Standard Height Foot Shell.
- Only difference is height of the shell: 15 mm shorter.
- Connection cap is not available for the Low Height Foot Shells.

Code	Foot Size	Heel Height	Color	Side
LAS-23L/R	23	10mm	Beige	L/R
LAS-24L/R	24	10mm	Beige	L/R
LAS-25L/R	25	10mm	Beige	L/R
LAS-26L/R	26	10mm	Beige	L/R
LAS-27L/R	27	10mm	Beige	L/R
LAS-28L/R	28	10mm	Beige	L/R
LAS-29L/R	29	10mm	Beige	L/R

Code	Foot Size	Heel Height	Color	Side
LAB-23L/R	23	10mm	Brown	L/R
LAB-24L/R	24	10mm	Brown	L/R
LAB-25L/R	25	10mm	Brown	L/R
LAB-26L/R	26	10mm	Brown	L/R
LAB-27L/R	27	10mm	Brown	L/R
LAB-28L/R	28	10mm	Brown	L/R
LAB-29L/R	29	10mm	Brown	L/R

## Order Example

**LAS-26-LEFT**  
 Beige Color | Size | Foot Shell Type

**LAB-26-RIGHT**  
 Brown Color | Size | Foot Shell Type

## Accessory



Foot Shell Tool ( FST )

## Foot Shell Removal Tool

- A tool for removing the foot from the foot shell.
- Works with all kind of carbon feet.
- One end is a hook type bent and the other end is a flat for applying a force.
- Made by stainless steel for durability and to avoid corrosion in long term.

Code	Material
FST	Stainless Steel



Spectra Sock

## Spectra Sock

- Spectra Sock made by special Fiber Glass material.
- High wear resistance.
- Suitable for all kind of carbon feet.

Code	Material	Color
B-CF	Fiber Glass	Black

## Overall Look of Carbon Foot Family

	 K1	 K2	 K3	 K4	Summary
					<p>Winged Foot</p> <ul style="list-style-type: none"> <li>• +/- 5° of Pyramid Torsion</li> <li>• +/- 10° of Inversion &amp; Eversion</li> <li>• Impact Absorbtion</li> <li>• High Energy Return</li> </ul>
					<p>Supreme Foot</p> <ul style="list-style-type: none"> <li>• Suitable for Excessive activites</li> <li>• High Impact Absorbtion</li> <li>• +/- 10° of Inversion &amp; Eversion</li> <li>• High Energy Return</li> </ul>
					<p>VACX Foot</p> <ul style="list-style-type: none"> <li>• Vacuum Integrated Carbon Foot</li> <li>• Impact Absorption converts to vacuum</li> <li>• High Energy Return</li> <li>• +/- 10° of Inversion &amp; Eversion</li> </ul>
					<p>AbsorbX Foot</p> <ul style="list-style-type: none"> <li>• 8mm Shock Absorption</li> <li>• High Energy Return</li> <li>• +/- 10° of Inversion &amp; Eversion</li> </ul>
					<p>Swipe Foot</p> <ul style="list-style-type: none"> <li>• Carbon Feet with Polycentric Ankle Design</li> <li>• Impact Absorption</li> <li>• Excessive Energy Return</li> <li>• Comfortable Gait Cycle</li> </ul>
					<p>Short Foot</p> <ul style="list-style-type: none"> <li>• Short Profile Design</li> <li>• Moderate Impact Absorbtion</li> <li>• Moderate Energy Retun</li> </ul>
					<p>FM-Foot</p> <ul style="list-style-type: none"> <li>• Split Foam Base</li> <li>• Split Carbon Plate</li> <li>• Lightweight Design (≈310gr)</li> </ul>



## Prosthetic Foot & Modular Adapters





E 60-22R

### Sach Foot

- Two different color options available (Beige and Brown).
- With separated toe.
- Enclosed heel bumper.

Code	Foot Size	Load Weight	Heel Height	Color
E 60-22L/R	22	100 kg	10 mm	Beige
E 60-23L/R	23	100 kg	10 mm	Beige
E 60-24L/R	24	100 kg	10 mm	Beige
E 60-25L/R	25	100 kg	10 mm	Beige
E 60-26L/R	26	100 kg	10 mm	Beige
E 60-27L/R	27	100 kg	10 mm	Beige
E 60-28L/R	28	100 kg	10 mm	Beige
E 60-29L/R	29	100 kg	10 mm	Beige

Code	Foot Size	Load Weight	Heel Height	Color
E 63-22L/R	22	100 kg	10 mm	Brown
E 63-23L/R	23	100 kg	10 mm	Brown
E 63-24L/R	24	100 kg	10 mm	Brown
E 63-25L/R	25	100 kg	10 mm	Brown
E 63-26L/R	26	100 kg	10 mm	Brown
E 63-27L/R	27	100 kg	10 mm	Brown
E 63-28L/R	28	100 kg	10 mm	Brown
E 63-29L/R	29	100 kg	10 mm	Brown



E 62-26L

### Dynamic Foot

- Manufactured with updated inner core – engineered plastics.
- Update: Waterproof
- The foot comes together with the Adapter
- Waterproofing is only valid if its adapter is not replaced
- All sizes come as separate toe

Code	Foot Size	Load Weight	Heel Height	Side
E 62-22L/R	22	100 kg	10 mm	L/R
E 62-23L/R	23	100 kg	10 mm	L/R
E 62-24L/R	24	100 kg	10 mm	L/R
E 62-25L/R	25	100 kg	10 mm	L/R
E 62-26L/R	26	100 kg	10 mm	L/R
E 62-27L/R	27	100 kg	10 mm	L/R
E 62-28L/R	28	100 kg	10 mm	L/R

### Order Example

**E 60-23-RIGHT**

Code      Size      Foot Type



E 62  
Bottom Surface





## Sach Foot and Dynamic Foot Adapter

- Complete with cap screw
- Foot adapter is used to connect the prosthetic foot to the distal connection of the modular prosthesis



Code	Screw	Material	Weight	Weight Limit
E 01s-M8	M8	Stainless Steel	110 gr	125 kg
E 01s-M10	M10	Stainless Steel	128 gr	125 kg

Code	Screw	Material	Weight	Weight Limit
E 01T-M8	M8	Titanium	86 gr	125 kg
E 01T-M10	M10	Titanium	98 gr	125 kg

Code	Screw	Material	Weight	Weight Limit
E 01AI-M8	M8	Aluminum	110 gr	100 kg
E 01AI-M10	M10	Aluminum	96 gr	100 kg

- This product has Aluminum body along with Titanium pyramid.

### Order Example

Code	Material
<b>E 01s-M10</b>	—— <b>Stainless Steel</b> , M10 Screw
<b>E 01T-M10</b>	—— <b>Titanium</b> , M10 Screw
<b>E 01AI-M10</b>	—— <b>Aluminum</b> , M10 Screw

## Accessory

Sach Foot Accessory ( E 60 Mika)

- Made of Plastics
- Used with sach foot adapter



Code  
E 60 mika

Modular Single Axis

Foot Accessory ( E 61 Cup)

- Made of Plastics
- Used with single axis foot adapter



Code	Size	Material
E 61cup-22	22 cm	plastic
E 61cup-23	23 cm	plastic
E 61cup-24	24 cm	plastic
E 61cup-25	25 cm	plastic
E 61cup-26	26 cm	plastic
E 61cup-27	27 cm	plastic
E 61cup-28	28 cm	plastic



E 61-22L

## Single Axis Foot And Adapters

### Single Axis Foot

Code	Foot Size	Load Weight	Heel Height	Side
E 61-22L/R	22	100 kg	10 mm	L/R
E 61-23L/R	23	100 kg	10 mm	L/R
E 61-24L/R	24	100 kg	10 mm	L/R
E 61-25L/R	25	100 kg	10 mm	L/R
E 61-26L/R	26	100 kg	10 mm	L/R
E 61-27L/R	27	100 kg	10 mm	L/R
E 61-28L/R	28	100 kg	10 mm	L/R
E 61-29L/R	29	100 kg	10 mm	L/R

### Order Example

**E 61-25-LEFT**

Code      Size      Foot Type



E 50s(22-25)



E 50T(22-25)



E 50Al(22-25)

### Modular Single Axis Foot Adapter

- The Single Axis Foot Adapters are used for connection of the Single-Axis Feet with an adapter pyramid receiver.

Code	Size	Material	Weight	Weight Limit
E 50s(22-25)	22-25	Stainless Steel	240 gr	125 kg
E 50s(26-30)	26-30	Stainless Steel	255 gr	125 kg

Code	Size	Material	Weight	Weight Limit
E 50T(22-25)	22-25	Titanium	195 gr	125 kg
E 50T(26-30)	26-30	Titanium	200 gr	125 kg

Code	Size	Material	Weight	Weight Limit
E 50Al(22-25)	22-25	Aluminum	215 gr	100 kg

- All bumpers are made by high quality Polyurethane.
- Titanium Single Axis Foot adapter is made by Titanium Hot Forging technology.



### Pyramid Receivers

#### 4 Hole Adapter W/ Fixed Receiver

- The socket adapters are to be used for mounting onto the socket of the transfemoral and transtibial Prosthesis
- Used to connect different modular parts and socket attachment block

Code	Material	Weight	Weight Limit
E 02s	Stainless Steel	85 gr	100 kg
E 02s-134 kg	Stainless Steel	95 gr	134 kg



Code	Material	Weight	Weight Limit
E 02T	Titanium	65 gr	100 kg
E 02T-134 kg	Titanium	80 gr	134 kg



Code	Material	Weight	Weight Limit
E 02Al	Aluminum	58 gr	100 kg



#### 4 Hole Adapter W/ Rotating Receiver

- The socket adapters are to be used for mounting onto the socket of the transfemoral and transtibial Prosthesis
- Free rotation adjustment

Code	Material	Weight	Weight Limit
E 02s-2	Stainless Steel	134 gr	125 kg



Code	Material	Weight	Weight Limit
E 02T-2	Titanium	80 gr	125 kg



## Pyramid Receivers And Adapters

### 4 Hole Adapter W/Rotating Receiver W/M5x20 Screw

- Free rotation adjustment by thread

Code	Material	Weight	Weight Limit
E 04s-Rs	Stainless Steel	134 gr	125 kg
E 04s-Ps	Stainless Steel	130 gr	125 kg
E04AI	Aluminum	80 gr	100 kg
E 04T-RT	Titanium	85 gr	125 kg
E 04T-PT	Titanium	81 gr	125 kg
E 04T-Plate	Titanium	45 gr	125 kg



### 4 Hole Adapter W/Rotating Receiver W/ Tooth

- Threaded adapter.

Code	Material	Weight	Weight Limit
E 02s-2D	Stainless Steel	129 gr	125 kg



### Rotating 4 Hole Adapter W/Fixed Pyramid

- With pyramid
- Hole through pyramid

Code	Material	Weight	Weight Limit
E 30s	Stainless Steel	108 gr	125 kg
E 30T	Titanium	58 gr	125 kg



### Rotating 4 Hole Adapter W/Fixed Receiver

- With pyramid receiver

Code	Material	Weight	Weight Limit
E 31s	Stainless Steel	111 gr	125 kg
E 31T	Titanium	68 gr	125 kg



Pyramid Adapters

4 Hole Adapter W/Fixed Pyramid

- Used to connect different modular parts and socket attachment blocks
- With pyramid and hole trough pyramid

Code	Material	Weight	Weight Limit
E 03s	Stainless Steel	93 gr	100 kg
E 03s-134 kg	Stainless Steel	118 gr	134 kg
E 03s-4-134 kg	Stainless Steel	84 gr	134 kg



Code	Material	Weight	Weight Limit
E 03T	Titanium	56 gr	100 kg
E 03T-134 kg	Titanium	70 gr	134 kg
E 03T-4-134 kg	Titanium	60 gr	134 kg



Code	Material	Weight	Weight Limit
E 03Al	Aluminum	63 gr	100 kg

- This Product has Aluminum body along with Titanium Pyramid



### 4 Prong Socket Adapter W/Center Hole

- For direct lamination onto BK socket
- With pyramid hole trough pyramid and lamination anchor
- All socket adapters comes with its cushion dummy (E12-C)



Code	Material	Weight	Weight Limit
E 12s	Stainless Steel	90 gr	125 kg
E 12s-134 kg	Stainless Steel	110 gr	134 kg



Code	Material	Weight	Weight Limit
E 12T	Titanium	66 gr	134 kg

- This Product is produced by Titanium forging technology.



Code	Material	Weight	Weight Limit
E 12AI	Aluminum	71 gr	100 kg

- This Product has Aluminum Body Along with Titanium Pyramid.



### E58 Interim AK Socket Adapter

- Temporary (Interim) Socket Adapter tool which helps to make alignment on the patient.

Code	Material	Qty.
E 58	Stainless Steel Aluminum	1 Body & 2 Bars



4 Prong Socket Adapter Large

- For direct lamination onto BK socket
- With pyramid hole trough pyramid and lamination anchor
- Adapter diameter is 72 mm.

Code	Material	Weight	Weight Limit
E 13s	Stainless Steel	108 gr	125 kg



4 Hole Adapter W/Rotating Pyramid

- Used to connect different modular parts and socket attachment blocks
- With pyramid and hole trough pyramid
- Rotatable

Code	Material	Weight	Weight Limit
E 03s-2	Stainless Steel	120 gr	125 kg



Code	Material	Weight	Weight Limit
 E 03T-2	Titanium	74 gr	125 kg



Eccentric 4 Hole Adapter Axial /Diagonal

- The eccentric arrangement of the pyramid offers a sliding adjustment of the prosthetic socket

Code	Material	Weight	Weight Limit
E 03s-ECC-A	Stainless Steel	105 gr	125 kg
 E 03T-ECC-A	Titanium	62 gr	125 kg

- Axially offset by 5 mm.



Code	Material	Weight	Weight Limit
E 03s-ECC-D	Stainless Steel	110 gr	125 kg
 E 03T-ECC-D	Titanium	62 gr	125 kg

- Diagonal offset by 5 mm.



Rotatable & Sliding Adjustment Adapter

- Allows easy adjustment by rotating and sliding at the same time
- Capable to rotate 360° and slide 11 mm at maximum range
- Thanks to its short length, allows the easy alignment and saves extra places
- Can be attached directly to the following socket adapters:



Code	Material	Weight	Weight Limit
E 35s	Stainless Steel	190 gr	100 kg
E 36s	Stainless Steel	235 gr	100 kg
E 35T	Titanium	115 gr	100 kg
E 36T	Titanium	144 gr	100 kg



- Ready-made combinations with E04 series Plate:

Code	Material	Weight	Weight Limit
E 35s-P	Stainless Steel	251 gr	100 kg
E 36s-P	Stainless Steel	296 gr	100 kg
E 35T-P	Titanium	153 gr	100 kg
E 36T-P	Titanium	182 gr	100 kg





E 33s

### Slide Adapters

- For an additional translation movement between prosthetic socket and tube adapter, even if the prosthesis is already in place.
- With pyramid receiver
- With 30mm diameter tube receiver



E 38s

Code	Material	Weight	Weight Limit
E 33s	Stainless Steel	284 gr	100 kg
E 34s	Stainless Steel	326 gr	100 kg
E 38s	Stainless Steel	245 gr	100 kg
E 39s	Stainless Steel	289 gr	100 kg



E 34s

Code	Material	Weight	Weight Limit
E 33T	Titanium	175 gr	100 kg
E 34T	Titanium	206 gr	100 kg
E 38T	Titanium	152 gr	100 kg
E 39T	Titanium	173 gr	100 kg



E 39s

### Tube Assembly

- Tube adapters are used as components for modular lower limb prostheses. They connect the prosthetic foot to the proximal components. Adapter combinations allow for controlled angle and length adaptation in the sagittal and frontal plane as well as adjustment of inward and outward rotation
- Available lengths 250mm-400mm



Code	Lentgh	Material	Weight	Weight Limit
E 05s-250	250	Stainless Steel	207 gr	125 kg
E 05s-400	400	Stainless Steel	272 gr	125 kg
E 05s-400-134 kg	400	Stainless Steel	285 gr	134 kg
E 05s-250-134 kg	250	Stainless Steel	236 gr	134 kg



Code	Lentgh	Material	Weight	Weight Limit
E 05T-250	250	Titanium	167 gr	125 kg
E 05T-400	400	Titanium	230 gr	125 kg
E 05T-400-134 kg	400	Titanium	245 gr	134 kg
E 05T-250-134 kg	250	Titanium	197 gr	134 kg



Code	Lentgh	Material	Weight	Weight Limit
E 05Al-250	250	Aluminum	188 gr	100 kg
E 05Al-400	400	Aluminum	270 gr	100 kg



Top view of water discharge channels on waterproof adapters

### Diameter 34 Tube Assembly

- Outer diameter is 34 mm.
- Limit weight is 134 kg.



Code	Lentgh	Material	Weight	Weight Limit
E05s-250-Dia34	250	Stainless Steel	270 gr	134 kg
E05s-400-Dia34	400	Stainless Steel	350 gr	134 kg
E05T-250-Dia34	250	Titanium	215 gr	134 kg
E05T-400-Dia34	400	Titanium	300 gr	134 kg



## 10d – 20d Angled Tube Assembly

- 10° - 20° tilted pyramid receiver adapter
- Available in Stainless steel and Titanium
- Available lengths 250mm-400mm



### 10° Tilted

Code	Lentgh	Material	Weight	Weight Limit
E05s-10D-250	250	Stainless Steel	212 gr	125 kg
E05s-10D-400	400	Stainless Steel	276 gr	125 kg
E05T-10D-250	250	Titanium	170 gr	125 kg
E05T-10D-400	400	Titanium	233 gr	125 kg



### 20° Tilted

Code	Lentgh	Material	Weight	Weight Limit
E05s-20D-250	250	Stainless Steel	241 gr	125 kg
E05s-20D-400	400	Stainless Steel	306 gr	125 kg
E05T-20D-250	250	Titanium	186 gr	125 kg
E05T-20D-400	400	Titanium	251 gr	125 kg



## Aluminum Tubes

- Available weight limits: 125 kg, 134 kg
- Available Lengths: 400 mm, 450 mm, 500 mm
- Black and blue color options are available for high-volume orders

Code	Material	Weight	Weight Limit	Diameter
Al400	Al-tube 400mm	186 gr	125 kg	30x2,5
Al450	Al-tube 450mm	210 gr	125 kg	30x2,5
Al500	Al-tube 500mm	232 gr	125 kg	30x2,5
Al400-Dia34	Al-tube 400mm	230 gr	134 kg	34x2
Al250-Dia34	Al-tube 250mm	155 gr	134 kg	34x2

## Tube Clamp Adapters

- Standard tube clamp adapters with the height of 47 mm.
- For the tubes of Dia. 30 mm.
- M8 Set-Screws are zinc-coated
- Titanium versions have special **“Water Channels”** for proper water discharge and contains A2 Stainless Steel Set-Screws.



E07s



E07T



E07AI



Code	Material	Weight	Weight Limit
E 07s	Stainless Steel	106 gr	125 kg
E 07s-134 kg	Stainless Steel	114 gr	134 kg
E 07T	Titanium	60 gr	125 kg
E 07T-134 kg	Titanium	64 gr	134 kg
E 07AI	Aluminum	76 gr	100 kg

Top view of water discharge channels on waterproof adapters

## Special Tube Clamp Adapters



E06s



E06T

- Short type tube clamp adapters with the height of 40 mm.
- Feature: Mounting height is 14 mm.
- For the tubes of Dia. 30 mm.
- M8 Set-Screws are zinc-coated

Code	Material	Weight	Weight Limit
E 06s	Stainless Steel	115 gr	100 kg
E 06T	Titanium	74 gr	100 kg

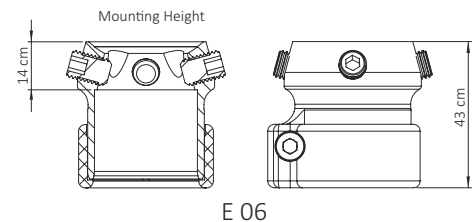

## 5 mm Offset- Tube Adapter

- There is a 5 mm offset between tube center and pyramid receiver sections



E 06s-5 mm

Code	Material	Weight	Weight Limit
E 06s-5mm	Stainless Steel	158 gr	100 kg
E 06T-5mm	Titanium	93 gr	100 kg

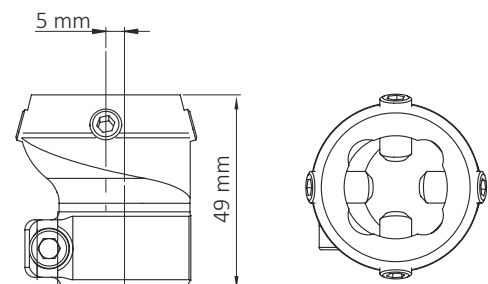



### Angled Tube Clamp Adapters

Code	Material	Weight	Weight Limit
E 07s-10D	Stainless Steel	132 gr	125 kg
E 07T-10D	Titanium	82 gr	125 kg
E 07s-20D	Stainless Steel	167 gr	125 kg
E 07T-20D	Titanium	102 gr	125 kg



### Diameter 34 Tube Clamp Adapters

- Tube clamp adapters for Dia. 34 mm Tubes.
- M8 Set-Screws are zinc-coated
- Weight limits are 134 Kg.

Code	Material	Weight	Weight Limit
E 07s-Dia34	Stainless Steel	150 gr	134 kg
E 07T-Dia34	Titanium	95 gr	134 kg



### Tube Clamp Adapters with Pyramid

- Tube clamp adapters with Pyramid head.
- For the tubes of Dia. 30 mm.

Code	Material	Weight	Weight Limit
E 08s	Stainless Steel	119 gr	100 kg
E 08T	Titanium	73 gr	100 kg

### Tube Adapter W/Receiver

- Connection adapters provide the connection between a tube clamp and a pyramid adapter. They differ in diameter, in length, and in the connection.



Code	Material	Weight	Weight Limit
E 57s-32	Stainless Steel	96 gr	100 kg
E 57s-60	Stainless Steel	155 gr	100 kg
E 57T-32	Titanium	60 gr	100 kg
E 57T-60	Titanium	95 gr	100 kg



E 09s-Body



E 10s-Body



E 11s



E 09s-Large Body

## Lamination Anchors

### Socket Adapters

- Lamination anchors are laminated into a prosthetic socket. They serve to connect the prosthetic socket to the distal prosthetic component.



Code	Material	Weight	Weight Limit
E 09s-Body	Stainless Steel	105 gr	125 kg
E 10s-Body	Stainless Steel	74 gr	125 kg

### Fixed Pyramid Socket Adapters

- Hardness of pyramid section kept high to handle screw pressure. On the other hand, Hardness of the prongs has been reduced by heat treatment, it can therefore be bent back and forth.

Code	Material	Weight	Weight Limit
E 11s	Stainless Steel	138 gr	125 kg

### Large Type Socket Adapters

- This 3 prong socket adapter is specially designed for big stumps. Size of the adapter is three times bigger than regular socket adapter.
- Thanks to its material, even though the big prongs, it's easy to bend them back and forth.
- Combination with pyramids and receivers are at next page.

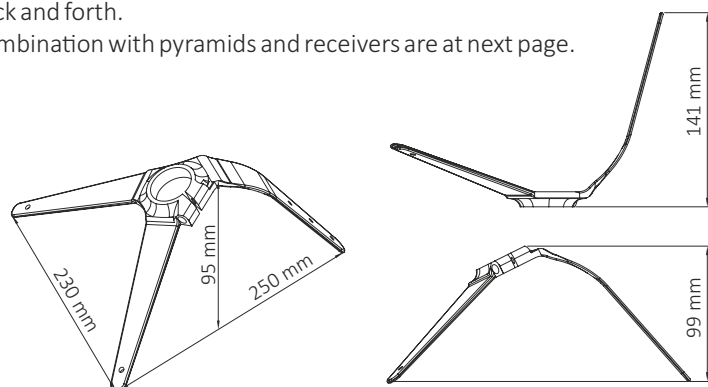

Code	Material	Weight	Weight Limit
E 09s-Large Body	Stainless Steel	275 gr	134 kg



Rotatable Pyramids

- The pyramid with threaded connector is available as an individual component of lamination anchor.

Code	Material	Weight	Weight Limit
Ps-Short	Stainless Steel	60 gr	125 kg
Ps-Short-134 kg	Stainless Steel	66 gr	134 kg
PT-Short	Titanium	35 gr	125 kg



3 And 4 Prong Socket Adapter  
W/Rotating Pyramid

Code	Material	Weight	Weight Limit
E 09s-Ps	Stainless Steel / Stainless Steel	165 gr	125 kg
E 09s-PT	Stainless Steel / Titanium	140 gr	125 kg



Code	Material	Weight	Weight Limit
E 10s-Ps	Stainless Steel / Stainless Steel	134 gr	125 kg
E 10s-PT	Stainless Steel / Titanium	109 gr	125 kg



Code	Material	Weight	Weight Limit
E 09s-Large Body-Ps	Stainless Steel / Stainless Steel	340 gr	134 kg



### Rotatable Receivers

- The pyramid receiver with threaded connector is available as an individual component of lamination anchor

Code	Material	Weight	Weight Limit
Rs-Short	Stainless Steel	70 gr	125 kg
Rs-Short-134 kg	Stainless Steel	88 gr	134 kg
RT-Short	Titanium	40 gr	125 kg



### 3 And 4 Prong Socket Adapter W/Rotating Receivers

Code	Material	Weight	Weight Limit
E 09s-Rs	Stainless Steel / Stainless Steel	175 gr	125 kg
E 09s-RT	Stainless Steel / Titanium	145 gr	125 kg



Code	Material	Weight	Weight Limit
E 10s-Rs	Stainless Steel / Stainless Steel	144 gr	125 kg
E 10s-RT	Stainless Steel / Titanium	114 gr	125 kg



Code	Material	Weight	Weight Limit
E 09s-Large Body-Rs	Stainless Steel / Stainless Steel	363 gr	134 kg



E 35T-3P



E 35T-4P



E 36T-3P



E 36T-4P

3 and 4 Prong Socket Adapters with Sliding and Rotating Combined

- These products are the combinations of E35 and E36 series, together with the prong adapters
- Allows easy adjustment by rotating and sliding at the same time
- Capable to rotate 360° and slide 11 mm at maximum range
- Thanks to its short length, allows easy alignment and saves extra space

Code	Material	Weight	Weight Limit
E 35T-3P	Titanium / S. Steel	220 gr	100 kg
E 35T-4P	Titanium / S. Steel	190 gr	100 kg
E 36T-3P	Titanium / S. Steel	250 gr	100 kg
E 36T-4P	Titanium / S. Steel	220 gr	100 kg

Code	Material	Weight	Weight Limit
E 35s-3P	S. Steel / S. Steel	295 gr	100 kg
E 35s-4P	S. Steel / S. Steel	265 gr	100 kg
E 36s-3P	S. Steel / S. Steel	340 gr	100 kg
E 36s-4P	S. Steel / S. Steel	310 gr	100 kg



Ps-long

Rs-long

### Long Rotatable Pyramids and Receivers

- The pyramid and pyramid receiver with threaded connector is available as an individual component of lamination anchor

Code	Material	Weight	Weight Limit
Ps-Long	Stainless Steel	180 gr	125 kg
Rs-long	Stainless Steel	190 gr	125 kg
PT-Long	Titanium	107 gr	125 kg
RT-long	Titanium	110 gr	125 kg



E 09s-Ps-long



E 09s-Rs-long

### 3 Prong Socket Adapter W/Rotating Pyramid and Receiver

Code	Material	Weight	Weight Limit
E 09s-Ps-Long	Stainless Steel / Stainless Steel	285 gr	125 kg
E 09s-PT-Long	Stainless Steel / Titanium	212 gr	125 kg
E 09s-Rs-long	Stainless Steel / Stainless Steel	295 gr	125 kg
E 09s-RT-long	Stainless Steel / Titanium	215 gr	125 kg



E 37s

### M36 Thread with Pyramid Receiver

Code	Material	Weight	Weight Limit
E 37s	Stainless Steel	65 gr	125 kg
E 37T	Titanium	40 gr	125 kg



H03s



H04s

### Pyramid Adapter with M36 Inner Thread

Code	Material	Weight	Weight Limit
H03s	Stainless Steel	130 gr	125 kg
H04s	Stainless Steel	120 gr	125 kg
H03T	Titanium	80 gr	125 kg
H04T	Titanium	70 gr	125 kg



## Double Adapters with Adjustment Screws

- Double adapters have pyramid adjustment cores on both sides.
- M8 adjustment screws are zinc-coated.
- Under the certain demand, titanium versions can be converted to the Waterproof product with water discharge channels and A2 Stainless Steel set screws.

Dual adapter is available in different sizes



Code	Height	Material	Weight	Weight Limit
E 15s-32	32 mm	Stainless Steel	130 gr	125 kg
E 15s-45	45 mm	Stainless Steel	148 gr	125 kg
E 15s-60	60 mm	Stainless Steel	167 gr	125 kg
E 15s-75	75 mm	Stainless Steel	185 gr	125 kg



Code	Height	Material	Weight	Weight Limit
E 15T-32	32 mm	Titanium	86 gr	125 kg
E 15T-45	45 mm	Titanium	98 gr	125 kg
E 15T-60	60 mm	Titanium	110 gr	125 kg
E 15T-75	75 mm	Titanium	120 gr	125 kg



Code	Height	Material	Weight	Weight Limit
E 15Al-32	32 mm	Aluminum	85 gr	100 kg
E 15Al-45	45 mm	Aluminum	102 gr	100 kg
E 15Al-60	60 mm	Aluminum	112 gr	100 kg
E 15Al-75	75 mm	Aluminum	120 gr	100 kg

## Double Adapter

### Double Adapter Pyramid/Pyramid

- The Double Adapters provide the connection between two prosthetic components with pyramid receiver



Code	Material	Weight	Weight Limit
E 18s	Stainless Steel	134 gr	125 kg
E 18T	Titanium	77 gr	125 kg
E 18Al	Aluminum	75 gr	100 kg

- E 18Al product has aluminum body along with titanium pyramid.

### Double Adapter Pyramid/Receiver

- The double adapter features a pyramid adapter and pyramid receiver. It serves as a connector between prosthetic components. Proximal and distal angle adjustments are possible in the frontal and sagittal planes.



Code	Height	Material	Weight	Weight Limit
E 21s-32	32 mm	Stainless Steel	105 gr	125 kg
E 21s-34	34 mm	Stainless Steel	108 gr	125 kg
E 21s-45	45 mm	Stainless Steel	124 gr	125 kg
E 21s-60	60 mm	Stainless Steel	165 gr	125 kg
E 21s-75	75 mm	Stainless Steel	178 gr	125 kg



Code	Height	Material	Weight	Weight Limit
E 21T-32	32 mm	Titanium	69 gr	125 kg
E 21T-34	34 mm	Titanium	70 gr	125 kg
E 21T-45	45 mm	Titanium	83 gr	125 kg
E 21T-60	60 mm	Titanium	100 gr	125 kg
E 21T-75	75 mm	Titanium	113 gr	125 kg



## Attachment Blocks

### Socket Attachment Blocks

- The socket attachment blocks are bonded to the distal end of the prosthetic socket and then laminated together with it. They serve to connect the prosthetic socket to a socket adapter.
- E 20Socket Attachment blocks contains "Lamination Dummy" in the package.

Code	Material	Weight	Weight Limit
E 20Thick	Plastik/wood	335 gr	125 kg
E 20Thin	Plastik/wood	207 gr	125 kg



### Plastic Attachment Blocks

- Available diameters for Product; 75-80-85-90
- The socket attachment blocks are bonded to the distal end of the prosthetic socket and then laminated together with it. They serve to connect the prosthetic socket to a socket adapter.

Code	Material	Weight	Weight Limit
E 19-75	Delrin	51 gr	100 kg
E 19-80	Delrin	53 gr	100 kg
E 19-85	Delrin	55 gr	100 kg
E 19-90	Delrin	57 gr	100 kg



### Thermoplastic Attachment Blocks

- Available diameters for Product; 66-78-88
- The Modular Adapter is suitable for transtibial [below-knee] and transfemoral (above-knee) prostheses. It is used to create a detachable connection between thermoplastic sockets or frames and the Modular System components.



Code	Material	Weight	Weight Limit
E 90 Sanis	Stainless Steel	98 gr	100 kg
E 91-66	Aluminum	123 gr	100 kg
E 91-78	Aluminum	138 gr	100 kg
E 91-88	Aluminum	180 gr	100 kg



E 92

### 4-Hole Laminating Plate

- Aluminum laminating plate with anodizing
- 65 mm Diameter
- With threaded holes for connecting a 4-hole adapter
- Comes as package with dummies and stainless screws
- Updated: Waterproof!

Code	Material	Weight	Weight Limit
E 92	Aluminum	48 gr	125 kg



E 93

### Posterior Offset Plate

- Provides permanent posterior shift for TF sockets.
- Shifting length can be changed between 10 mm to 25 mm.
- Comes as package stainless screws.
- Waterproof!

Code	Material	Weight	Weight Limit
E 93	Aluminum	95 gr	100 kg





## Knee Joints





E 44



## E 44 Polycentric Knee Joint with Extension Mechanism

- Mechanical 4-Bar polycentric knee Joint, can be used as locked or unlocked
- Locking function for a high degree of safety; ideal for first standing and walking exercises, afterwards locking function is cancel-able.
- More ground clearance for a safer and more confident gait
- Rates of flexion and extension can be adapted to the user. Flexion range is up to 150°
- Integrated shift adjustment by adapter up to 5 mm.

### Data Table

Product Name with Pyramid Connection	E 44-A
Product Name with M36 Connection	E 44-B
Product Name with One-Prong Connection	E 44-C
Advised Activity Level	K1-K2
Material	Aluminum
Max. User Weight	125 Kg
Flexion Angle	150°
Product Weight	680 gr
Overall Length / Build Height	161 mm / 102mm



### Connection Adapter Types



Pyramid Connection



M36 Connection



One-Prong Connection

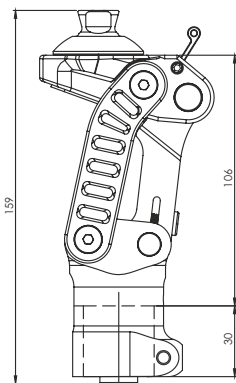

- E44 comes with a white protector knee cap in the package. The product can be used with or without this cap, based on preference.



### PN-100 Pneumatic Knee Joint

- Flexion and Extension individual adjustments
- Pneumatic Swing Phase Control
- Internal Extension Assist
- Stability Adjustment
- All-day-use, stable and reliable functionality

#### Data Table

Product Name	PN-100
Advised Activity Level	K2-K3
Material	Aluminum
Max. User Weight	100 Kg
Flexion Angle	145°
Product Weight	750 gr
Overall Length / Build Height	200 mm / 146 mm

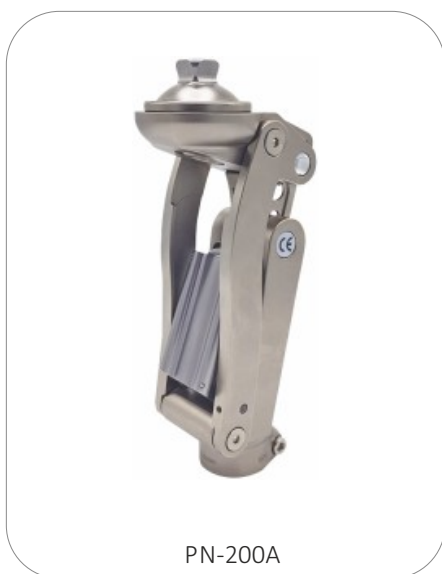
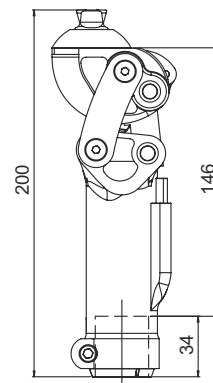

### PN-200 Pneumatic Knee Joint

- Flexion and Extension individual adjustments
- Pneumatic Swing Phase Control
- Internal Extension Assist
- Long 4-Bar Polycentric Design
- Pyramid and M36 connection adapter options
- Anterior – Posterior and Medial – Lateral shifts of 5 mm

#### Data Table

Product Name with Pyramid Connection	PN-200A
Product Name with M36 Connection	PN-200B
Advised Activity Level	K2-K3
Material	Aluminum
Max. User Weight	100 Kg
Flexion Angle	155°
Product Weight	944 gr
Overall Length / Build Height	214 mm / 158 mm

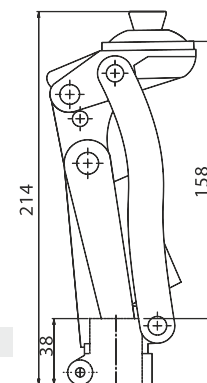

### Connection Adapter Types



Pyramid Connection



M36 Connection

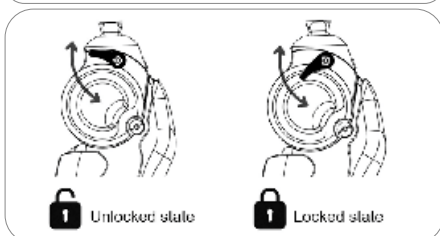
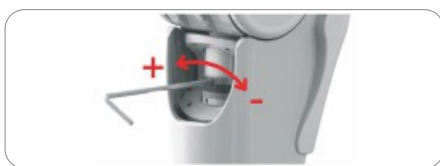

## Monocentric Knee Joint with Rotary Hydraulics

The HHS is a hydraulic prosthetic knee designed to provide smooth, secure, and natural movement for everyday walking. It supports users with reliable stance control while allowing a more fluid swing phase for comfortable gait progression. The system is built to adapt well to different walking speeds, helping create a more stable and confident experience. Its compact and durable construction makes it suitable for active daily use. The HHS is engineered to combine safety, mobility, and ease of adjustment in one advanced mechanical knee solution. Overall, it is a prosthetic component developed to improve balance, walking efficiency, and user confidence in daily life.

### Specifications

- Independent hydraulic control for swing and stance.
- Smooth and safe descent on stairs and ramps.
- Manual lock for extra stability while standing.
- Biomechanical design for more natural movement.
- Strong construction for active daily use
- Progressive damping for better knee security

### Technical Data

Product Code	HHS
Proximal Connection	Pyramid Adapter
Distal Connection	Tube Clamp Ø 34 mm
Weight	1167 gr
Overall Length / Build Height	232 mm / 195,5 mm
Max. User Weight	125 Kg
Max. Knee Flexion Angle	130 °
Water Condition	Fresh Water Waterproof

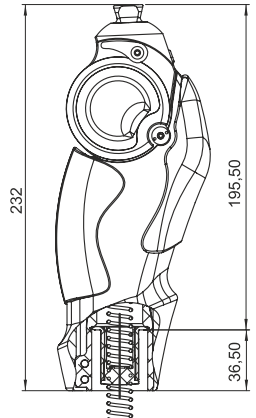

### Flexion and Extension Adjustment

- The HHS provides four adjustment options for stance and swing phase control. Flexion and extension resistance can be set independently with the valves that locates on both side of the product.

### Stance Phase Damping Adjustment

- Threshold sensitivity and stance phase damping resistance can be adjusted separately with two rings located on posterior of the product.

### Manual Lock Feature

- The HHS can be locked and unlocked manually with the small wings on both side of the product. This locks the rotary hydraulic unit and prevents rotation.



E 86

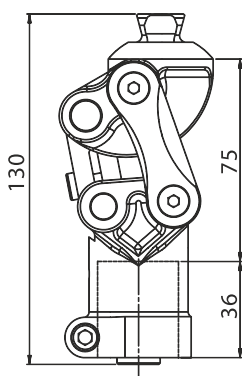

### E 86 Polycentric Knee Joint with Extension Mechanism

- Mechanical 4-Bar Polycentric Knee Joint
- Provides adjustable extension assist
- Friction control mechanism
- High knee flexion angle up to 160°
- Updated: Waterproof!

#### Data Table

Product Name	E 86
Advised Activity Level	K1-K2
Material	Aluminum
Max. User Weight	125 Kg
Flexion Angle	160°
Product Weight	450 gr
Overall Length / Build Height	130 mm / 75 mm



E 84

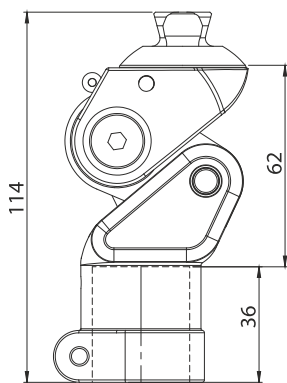

### E 84 Single Axis Knee Joint with Friction and Extension Mechanism

- Monocentric and lightweight knee joint, which can be used with weight-activated friction mechanism and also comes with a lock feature
- The knee automatically locks when extended
- Lock feature is cancel-able anytime desired, depending on the patient's progress
- Integrated extension assist spring is adjustable to suit individual requirements

#### Data Table

Product Name	E 84
Advised Activity Level	K1-K2
Material	Aluminum
Max. User Weight	125 Kg
Flexion Angle	145°
Product Weight	490 gr
Overall Length / Build Height	115 mm / 62 mm

### Single Axis Knee W/Manual Lock

- Monocentric knee joint with manual lock
- Up to 100 Kg body weight
- High Stance Phase stability
- Unlocking cable is included
- Feature: Can be unlocked with hand click, without need of cable.
- Feature: Waterproof! (Fresh and sea water included)
- Pyramid, M36 and One-Prong Lamination Anchor types are available.

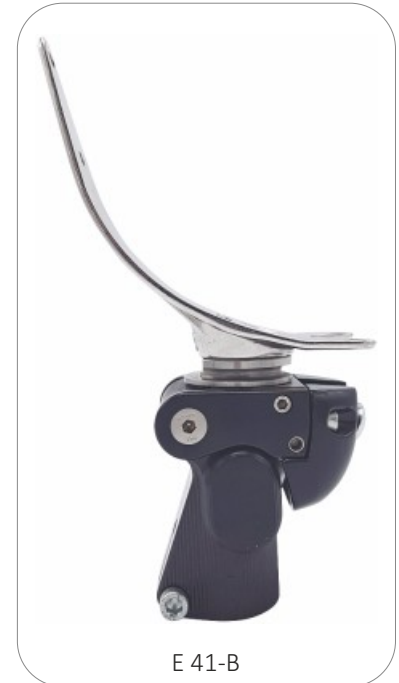

E 41

- Pyramid Connection



E 41-A

- M36 Connection

Code	Material	Weight	Weight Limit
E 41	Aluminum	433 gr	100 kg
E 41-A	Aluminum	400 gr	100 kg
E 41-B	Aluminum	570 gr	100 kg

### Body & Accessories



E 41-Prong Con.



E 41-One Prong



E 41-Adapter



E 41-Pyramid



E 41-Wire

Code	Material	Weight	Weight Limit
E 41-Pyramid	Stainless Steel	84 gr	100 kg
E 41-Prong Con.	Stainless Steel	95 gr	100 kg
E 41-One Prong	Stainless Steel	140 gr	100 kg
E 41-Adapter	Aluminum	45 gr	100 kg
E 41-Wire	Stainless Steel	95 gr	100 kg

Note: After each use in salt water, all the products of prosthesis must be rinsed with fresh water and should be dried. This operation will significantly improve life-span of the waterproof products.



ROT

### Rotation Adapter

#### Description

The ROT Rotation Adapter is a functional prosthetic component designed to improve comfort and mobility in above-knee prosthetic fittings. By enabling controlled rotational movement of the prosthetic limb when the knee is flexed, ROT allows users to perform everyday activities more naturally and with greater ease.

This rotation capability simplifies movements such as sitting comfortably, putting on shoes or socks, and positioning the prosthesis while driving or during daily tasks. The compact design integrates seamlessly into modular prosthetic systems, providing a reliable and practical solution for enhanced user convenience.

#### Features

- Allows controlled rotation of the prosthetic limb when the knee joint is flexed
- Improves comfort during everyday activities such as sitting, dressing, or driving
- Smooth rotation mechanism with reliable locking function
- Compact and durable construction for long-term performance
- Compatible with modular prosthetic systems
- Designed for a wide range of mobility levels



ROT-M36

Code	Material	Weight	Weight Limit
ROT	Stainless Steel	190 gr	125 kg
ROT-M36	Stainless Steel	215 gr	125 kg



E 49AI



Single Axis Knee W/Manuel Lock Aluminum

- For trans-femoral amputees
- Low functional level
- High stance phase stability
- No swing phase control
- Not recommended for patients with a medium and higher activity level

Code	Material	Weight	Weight Limit
E 49AI	Aluminum	350 gr	100 kg



E49 Spare Set

Code	Description
E49 Spare Set	Spare parts for the E 49AI Knee Joint



E 40

Single Axis Knee W/Lock Rotating Pyramid

- Uniaxial monocentric locked knee joint
- Made of aluminum material
- Provides 175 degrees of flexion
- Rotation pyramid
- Wire at front of the knee joint

Code	Material	Weight	Weight Limit
E 40	Aluminum	360 gr	100 kg



E 48

Single Axis Knee W/Manuel Lock And Rot. Pyramid W/Sided Wire

- Uniaxial monocentric locked knee joint
- Made of aluminum material
- Provides 160 degrees of flexion
- Rotation pyramid
- Wire at side of the knee joint

Code	Material	Weight	Weight Limit
E 48	Aluminum	347 gr	100 kg



E 42s

### Single Axis Friction Knee

- For patients requiring a high degree of stability
- Medium functional level
- High stance phase stability
- Medium swing phase control

Code	Material	Weight	Weight Limit
E 42s	Stainless Steel	485 gr	100 kg
E 42T	Titanium	376 gr	100 kg



E 42-EXT

### E42 Extension Assist W/Plastic Cover W/Wire

- Extension articulation of the frictional knee piece.

Code	Weight
E 42-EXT	.118 gr.



E 43s

### Single Axis Knee

- High stance phase stability
- Monocentric
- With lock and spring extension assist
- No swing phase control

Code	Material	Weight	Weight Limit
E 43s	Stainless Steel	540 gr	125 kg
E 43T	Titanium <b>NEW</b>	420 gr	125 kg



### Polycentric Knee Joint

- For trans-femoral amputees
- Medium functional level
- Medium stance phase stability
- Medium swing phase control
- Can be used also for hip disarticulation
- Not recommended for patients with a higher activity level

Code	Material	Weight	Weight Limit
E 53s	Stainless Steel	700 gr	100 kg
E 53T	Titanium	475 gr	100 kg

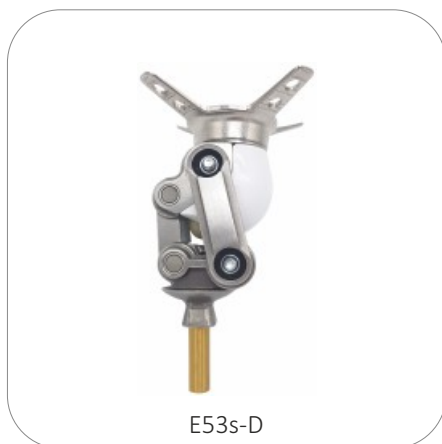

### Polycentric Knee for Disarticulation

- Swing phase adjustable
- Medium functional level
- Medium stance phase stability
- With self socket adapter, easy to apply on socket

Code	Material	Weight	Weight Limit
E53s-D	Stainless Steel	750 gr	100 kg



### Polycentric Knee for Disarticulation with One-Prong Adapter

- Swing phase adjustable
- Medium functional level
- Medium stance phase stability
- With self-socket One-Prong type adapter, easy to apply on socket

Code	Material	Weight	Weight Limit
E53s-L	Stainless Steel	790 gr	100 kg



E 45T

Disarticulation Knee

- For knee disarticulation amputees
- Medium stance phase stability
- Medium swing phase control

Code	Material	Weight	Weight Limit
E 45s	Stainless Steel	900 gr	100 kg
E 45T	Titanium	660 gr	100 kg



E 46s

Disarticulation Knee W/Manual Lock

- For knee disarticulation amputees
- High stance phase stability
- No swing phase control

Code	Material	Weight	Weight Limit
E 46s	Stainless Steel	900 gr	100 kg



E 88

Hip Joint with Extension Mechanism

- Mechanical 4-Bar Polycentric Hip Joint
- Provides adjustable extension assist
- Aluminum anodized body
- Angled Plate is included in the package

Code	Material	Weight	Weight Limit
E 88	Aluminum	520 gr	100 kg

# Silicone & Gel Liners





## SILICONE LINER SYSTEMS

### Specifications

- Made from Medical Grade Silicone Material.
- The silicones used have been tested for biocompatibility according to DIN EN ISO 10993-5 and DIN EN ISO 10993-10.
- High adhesion between liner and the skin.
- Seamless Fabric Cover.
- 3 mm or 6 mm uniform thickness.
- 2 different fabric cover has been used on outside. The fabric cover around the distal end has special "matrix" which prevents vertical stretch thus prevents the "pistoning movement".
- Perfect Pressure distribution.
- Suitable for nearly all locking devices.



Silicone Liner with Distal Connector

Code	Color	Distal Circumference	Thickness
SL-10-18	Grey	18 cm	3 mm
SL-10-20	Grey	20 cm	3 mm
SL-10-21	Grey	21 cm	3 mm
SL-10-22	Grey	22 cm	3 mm
SL-10-23,5	Grey	23,5 cm	3 mm
SL-10-25	Grey	25 cm	3 mm
SL-10-26,5	Grey	26,5 cm	3 mm
SL-10-28	Grey	28 cm	3 mm
SL-10-30	Grey	30 cm	3 mm
SL-10-32	Grey	32 cm	3 mm
SL-10-34	Grey	34 cm	3 mm
SL-10-36	Grey	36 cm	3 mm
SL-10-38	Grey	38 cm	3 mm
SL-10-40	Grey	40 cm	3 mm
SL-10-42	Grey	42 cm	3 mm
SL-10-45	Grey	45 cm	3 mm

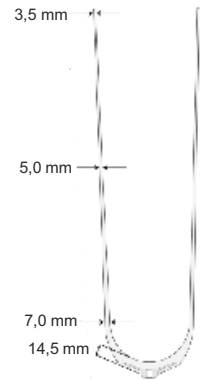

Silicone Liner without Distal Connector

Code	Color	Distal Circumference	Thickness
SL-18	Grey	18 cm	3 mm
SL-20	Grey	20 cm	3 mm
SL-21	Grey	21 cm	3 mm
SL-22	Grey	22 cm	3 mm
SL-23,5	Grey	23,5 cm	3 mm
SL-25	Grey	25 cm	3 mm
SL-26,5	Grey	26,5 cm	3 mm
SL-28	Grey	28 cm	3 mm
SL-30	Grey	30 cm	3 mm
SL-32	Grey	32 cm	3 mm
SL-34	Grey	34 cm	3 mm
SL-36	Grey	36 cm	3 mm
SL-38	Grey	38 cm	3 mm

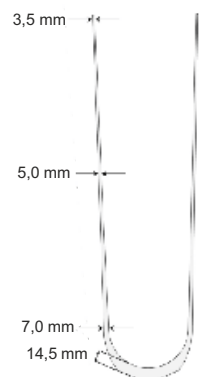



## SILICONE LINER SYSTEMS

### Specifications

- Made from Medical Grade Silicone Material.
- The silicones used have been tested for biocompatibility according to DIN EN ISO 10993-5 and DIN EN ISO 10993-10.
- High adhesion between liner and the skin.
- Seamless Fabric Cover.
- 3 mm or 6 mm uniform thickness.
- 2 different fabric cover has been used on outside. The fabric cover around the distal end has special "matrix" which prevents vertical stretch thus prevents the "pistoning movement".
- Perfect Pressure distribution.
- Suitable for nearly all locking devices.



Silicone Liner with Distal Connector

Code	Color	Distal Circumference	Thickness
SL-16-20	Grey	20 cm	6 mm
SL-16-22	Grey	22 cm	6 mm
SL-16-23,5	Grey	23,5 cm	6 mm
SL-16-25	Grey	25 cm	6 mm
SL-16-26,5	Grey	26,5 cm	6 mm
SL-16-28	Grey	28 cm	6 mm
SL-16-30	Grey	30 cm	6 mm
SL-16-32	Grey	32 cm	6 mm
SL-16-34	Grey	34 cm	6 mm
SL-16-36	Grey	36 cm	6 mm
SL-16-40	Grey	40 cm	6 mm
SL-16-45	Grey	45 cm	6 mm

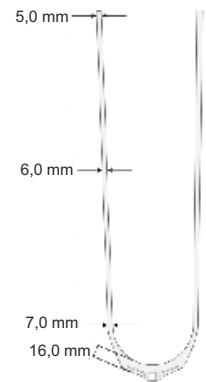

Silicone Liner without Distal Connector

Code	Color	Distal Circumference	Thickness
SL-06-20	Grey	20 cm	6 mm
SL-06-22	Grey	22 cm	6 mm
SL-06-23,5	Grey	23,5 cm	6 mm
SL-06-25	Grey	25 cm	6 mm
SL-06-26,5	Grey	26,5 cm	6 mm
SL-06-28	Grey	28 cm	6 mm
SL-06-30	Grey	30 cm	6 mm
SL-06-32	Grey	32 cm	6 mm
SL-06-34	Grey	34 cm	6 mm
SL-06-36	Grey	36 cm	6 mm

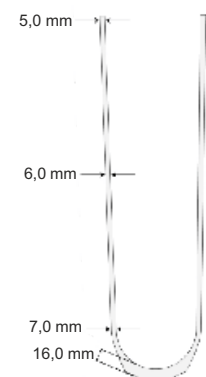



PERFORMANCE LINER SYSTEMS

Specifications

- Made from Medical Grade silicone material with antibacterial properties against bad odor.
- The new formulation enhances the product's durability and robustness for active use.
- New fabric has been developed for extreme performance, durable against wear and tears.
- Performance liners can be used in fresh, salt and chlorinated water!
- A special 10cm-long Matrix on distal end prevents the pistoning movement in the socket.
- Seamless fabric cover.
- 3mm uniform thickness.



Performance Liner  
with Distal  
Connector



Code	Color	Distal Circumference	Thickness
SL-10-18P	Dark Grey	18 cm	3 mm
SL-10-20P	Dark Grey	20 cm	3 mm
SL-10-21P	Dark Grey	21 cm	3 mm
SL-10-22P	Dark Grey	22 cm	3 mm
SL-10-23,5P	Dark Grey	23,5 cm	3 mm
SL-10-25P	Dark Grey	25 cm	3 mm
SL-10-26,5P	Dark Grey	26,5 cm	3 mm
SL-10-28P	Dark Grey	28 cm	3 mm
SL-10-30P	Dark Grey	30 cm	3 mm
SL-10-32P	Dark Grey	32 cm	3 mm
SL-10-34P	Dark Grey	34 cm	3 mm
SL-10-36P	Dark Grey	36 cm	3 mm
SL-10-38P	Dark Grey	38 cm	3 mm
SL-10-40P	Dark Grey	40 cm	3 mm
SL-10-42P	Dark Grey	42 cm	3 mm
SL-10-45P	Dark Grey	45 cm	3 mm

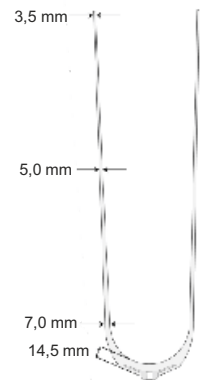

Performance Liner  
without Distal  
Connector

Code	Color	Distal Circumference	Thickness
SL-18P	Dark Grey	18 cm	3 mm
SL-20P	Dark Grey	20 cm	3 mm
SL-21P	Dark Grey	21 cm	3 mm
SL-22P	Dark Grey	22 cm	3 mm
SL-23,5P	Dark Grey	23,5 cm	3 mm
SL-25P	Dark Grey	25 cm	3 mm
SL-26,5P	Dark Grey	26,5 cm	3 mm
SL-28P	Dark Grey	28 cm	3 mm
SL-30P	Dark Grey	30 cm	3 mm
SL-32P	Dark Grey	32 cm	3 mm
SL-34P	Dark Grey	34 cm	3 mm
SL-36P	Dark Grey	36 cm	3 mm
SL-38P	Dark Grey	38 cm	3 mm

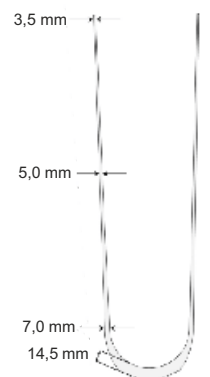



## GEL LINER SYSTEMS

### Specifications

- Made from Medical Grade TPE Gel Material
- The Gel Material used have been tested for biocompatibility according to DIN EN ISO 10993-5 and DIN EN ISO 10993-10.
- Non-uniform Gel Thickness (3 mm Posterior and 6 mm Anterior).
- With and without Distal Connector systems are available.



Gel Liner with Distal Connector



Gel Liner without Distal Connector

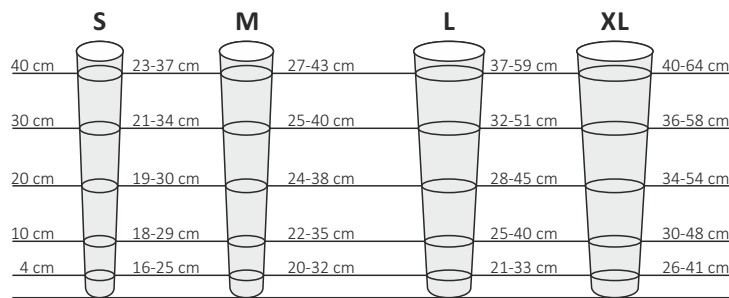

Code	Size	Thickness
GL-S-6-10	S	6 mm to 3 mm
GL-M-6-10	M	6 mm to 3 mm
GL-L-6-10	L	6 mm to 3 mm
GL-XL-6-10	XL	6 mm to 3 mm

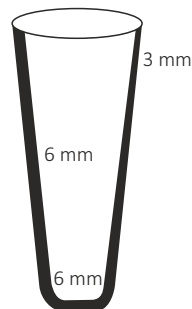

Code	Size	Thickness
GL-S-6	S	6 mm to 3 mm
GL-M-6	M	6 mm to 3 mm
GL-L-6	L	6 mm to 3 mm
GL-XL-6	XL	6 mm to 3 mm



Gel Suspension Sleeve

## SUSPENSION SLEEVES

### Specifications

- Made from Medical Grade TPE Gel Material.
- The Gel Material used have been tested for biocompatibility according to DIN EN ISO 10993-5 and DIN EN ISO 10993-10.
- 3 mm uniform thickness.
- Total length of the sleeve is around 340 mm.

Code	Size	Lower Circumference	Top Circumference
KP-S	S	15-22 cm	23-34 cm
KP-M	M	21-30 cm	29-43 cm
KP-MP	MP	24-35 cm	33-47 cm
KP-L	L	28-42 cm	36-51 cm
KP-LP	LP	31-46 cm	39-55 cm



Gel Suspension Sleeve

## SUSPENSION SLEEVES

### Specifications

- Made from Medical Grade TPE Gel Material.
- The Gel Material used have been tested for biocompatibility according to DIN EN ISO 10993-5 and DIN EN ISO 10993-10.
- 3 mm uniform thickness.
- Total length of the sleeve is about 400 mm.
- 15 degrees pre-flexed design.

Code	Size	Lower Circumference	Top Circumference
KM-S	S	15-22 cm	25-36 cm
KM-M	M	19-28 cm	29-43 cm
KM-L	L	22-37 cm	35-50 cm
KM-XL	XL	27-44 cm	39-56 cm



## Lock Systems & Valves





## Clutch Lock

- Secure and smooth locking mechanism designed for the daily use.
- The precision-engineered pin with worm-thread design ensures smooth engagement and reliable connection with the locking system.
- Supplied with an SL-Kit lamination dummy, allowing convenient and accurate integration during socket fabrication.
- **Update:** Improved release functionality enables pin disengagement **even under the load**, which allows users to press the release button and slide-remove the prosthesis socket at **same time**.



Code	Material	Weight	Weight Limit
E 70-Body	Aluminum	204 gr	125 kg
E 70-Kit	Aluminum	284 gr	125 kg
E 70-09-Kit	Aluminum	314 gr	125 kg

Code	Material	Weight	Weight Limit
E 71-Body	Aluminum	230 gr	125 kg
E 71-Kit	Aluminum	308 gr	125 kg
E 71-09-Kit	Aluminum	333 gr	125 kg

## Accessory



## Clutch Lock – E73

- Aluminum construction combined with a reinforced steel ring at the pin entrance ensures durability and reduced wear.
- Anti-rotation lamination disk designed with extra grooves to maintain stable positioning within the socket.
- Lamination dummy units are included.
- **Update:** Improved release functionality enables pin disengagement **even under the load**, which allows users to press the release button and slide-remove the prosthesis socket at **same time**.



E 73-Kit

### Accessories



Code	Material	Weight	Weight Limit
E 73-Kit	Aluminum	250 gr	125 kg

- Lamination dummy and assembly kit are included in package.



E 74

## Clutch Lock – E74

- An ideal solution for patients with joint contractures or unusual alignment conditions, providing easier prosthesis donning and doffing.
- Can be integrated directly into the socket during lamination or thermoplastic fabrication processes.
- No weight limit, as the locking mechanism is not a load-bearing component.
- Reinforced steel inner ring protects the pin entrance, reducing wear and extending service life.
- Dummy kit included in the package.
- **Updated:** Waterproof!

Code	Material	Weight	Weight Limit
E 74	Aluminum	125 gr	No weight limit

### Accessories



E 74-Pin

E 74-Dummy Kit

E 74-Gear

Note: After each use in salt water, all the products of prosthesis must be rinsed with fresh water and should be dried. This operation will significantly improve life-span of the waterproof products.



**Important** In case of regular water exposure, it is recommended to replace the internal gear set every 6–12 months, depending on usage frequency and water salinity.



E 75

### Cylindrical Shuttle Lock – E75

- E75 is a cylindrical type of lock, made of high-strength Nylon
- Designed for direct mounting with a 4-hole adapter
- Very light-weight structure
- Includes two pins in package

Code	Material	Weight	Weight Limit
E 75	H. Nylon	125 gr	100 kg



E 76

### Shuttle Lock – E76

- Basic socket in-built Shuttle lock with hexagon base.
- There is no weight limit because the lock is not a weight bearing component
- Simple and reliable design
- Build Height: 32 mm

Code	Material	Weight	Weight Limit
E 76	Delrin	70 gr	No weight limit



E72-36

### Shuttle Lock W/ Receiver

- Available diameters for E72;  $\varnothing = 36\text{mm}, 50\text{mm}$
- The shuttle lock serves to secure a suitable liner in the prosthetic socket. The shuttle lock is laminated distally into the prosthetic socket.
- Delrin lightweight body, suitable for bath prosthesis.
- Dummy kit is not included in the package and should be ordered separately.
- Dummy kit is only available for E72-50

Code	Material	Weight	Weight Limit
 E 72-36	Delrin	77 gr	100 kg



E72-50

Code	Material	Weight	Weight Limit
 E 72-50	Delrin	91 gr	100 kg

### Accessories



E72-50 Dummy kit



VAC-100-30



VAC-100-RR



## Active Vacuum Unit & Valves

### Active Vacuum Unit

The vacuum unit is designed to generate an elevated vacuum between user's liner and the socket to prevent pistoning movement and grip the stump firmly. To do this, there should be a sealed environment between user's liner and the socket. Once the environment is sealed, which is compressed and released during normal walking, the vacuum unit draws air from the socket through one-way valves and evacuates it through the pump. So vacuum unit, discharges the air in this sealed environment on every step of user. After multiple steps of the user, 15 in.Hg ( around 0.5 bar ) is created in the sealed socket environment.

#### Features

- Discharging the air between the socket and the liner on every step of user
- Prevents pistoning and keeps the prosthesis firmly on user.
- Absorbs high reaction forces of the ground ( Absorbs impact forces )
- Increases comfort of the user
- Has free rotating connector to easily adjust air suction hose



Standard Connector



DSC-Valve



VAC series comes with the Standard Connector. It's also possible to order DSC-Valve, which has a push-button feature to release the vacuum.

#### Connection Type: Pyramid Receiver & Tube Clamp

Code	Material	Weight Limit	Tube Diameter
VAC-60-30	Aluminum	60 kg	30
VAC-75-30	Aluminum	75 kg	30
VAC-100-30	Aluminum	100 kg	30
VAC-125-34	Aluminum	125 kg	34

#### Connection Type: Pyramid Receiver & Pyramid Receiver

Code	Material	Weight Limit	Connection Type
VAC-60-RR	Aluminum	60 kg	Receiver & Receiver
VAC-75-RR	Aluminum	75 kg	Receiver & Receiver
VAC-100-RR	Aluminum	100 kg	Receiver & Receiver

#### Push Button Release for VAC Series

Code	Material	Weight Limit	Connection Type
DSC-Valve	Aluminum	125 Kg	Push Button Release

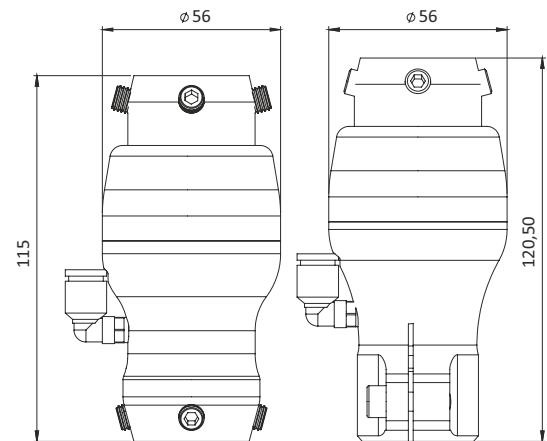

VAC-100-RR  
100 KG  
(RECEIVER - RECEIVER)

VAC-100-30  
100 KG  
(RECEIVER - TUBE)



## Valves

### AKS-Valve

- Auto-expulsion valve with push button for suction release.
- The valve expels air under positive pressure when the stump entering into the socket
- Designed to be used with all suction suspension systems.
- Recommended for TF (Transfemoral) Users.
- Product package includes the dummy kit.

Code	Material	Weight	Weight Limit
AKS-Valve	Aluminum & Delrin	22 gr	No weight limit

### Accessories (Included in package)



### EPS-Valve

- Expulsion valve with a button, provides one-way air discharge.
- Recommended for both TT and TF users.
- Designed to be used with all suction suspension systems.
- Body is made by anodized aluminum.

Code	Material	Weight
EPS-Valve	Aluminum body	10 gr



### One-way Valve (VAC-300)

- This valve enables the expulsion of excessive air out of the socket during stance phase and effectively prevents air from flowing in during swing phase
- Consisting of:
  - Valve body of anodized aluminum
  - Exchangeable sealing lip valve
  - Counter nut with o-ring
  - Foam filter insert

Code	Material	Outside Diameter
VAC-300	Aluminum	25 mm



### Automatic Flat Rubber Valve (VAC-200)

- Automatic one way valve
- With thump flap

Code	Material	Outside Diameter
VAC-200	Rubber	40 mm



### Connection Tube With Seat Ring

- For valves having an outside diameter of 40 mm

Code	Material	Outside Diameter
VAC-200-EXT	Rubber	40 mm

# *Components for Children*





E60-Children

## Children Sach Foot

- Small size Sach Foot products with fingers.
- With separate toe.

Code	Size	Load Weight	Heel Height
E 60-14L/R	14	60 kg	10 mm
E 60-15L/R	15	60 kg	10 mm
E 60-16L/R	16	60 kg	10 mm
E 60-17L/R	17	60 kg	10 mm
E 60-18L/R	18	60 kg	10 mm
E 60-19L/R	19	60 kg	10 mm
E 60-20L/R	20	60 kg	10 mm
E 60-21L/R	21	60 kg	10 mm



E 01Al-C

## Sach Foot Adapter for Children

- Adapter with aluminum body and stainless-steel pyramid
- Pyramid is small type, suitable for children prosthesis
- Comes with screw and the washer

Code	Material	Weight	Weight Limit
E 01Al-C	Aluminum	50 gr	45 kg



E 05Al-C

## Tube Adapter for Children

- Aluminum Tube Adapter with 22 mm diameter
- Pyramid receiver head is suitable for small type pyramids

Code	Material	Weight	Weight Limit
E 05Al-C	Aluminum	125 gr	45 kg



E 07AI-C

### Tube Clamp Adapter for Children

- Aluminum Tube Clamp Adapter with 22 mm inner diameter
- Pyramid receiver head is suitable for small type pyramids

Code	Material	Weight	Weight Limit
E 07AI-C	Aluminum	65 gr	45 kg



E 12AI-C

### Socket Adapter for Children

- Aluminum socket adapter with stainless-steel pyramid
- Pyramid is small type, suitable for children prosthesis
- Mostly suitable for BK prosthesis

Code	Material	Weight	Weight Limit
E 12AI-C	Aluminum	35 gr	45 kg



E 02AI-C

### Socket Adapter with Adjustment Screws for Children

- Aluminum socket adapter with adjustment screws
- Pyramid receiver head is suitable for small type pyramids
- Mostly suitable for AK prosthesis

Code	Material	Weight	Weight Limit
E 02AI-C	Aluminum	40 gr	45 kg



E 20-C

### Socket Attachment Block for Children

- Attachment block made by durable plastic
- Suitable for children prosthesis

Code	Material	Weight	Weight Limit
E 20-C	Plastic	85 gr	45 kg



E 81

Single Axis Knee Joint with Adjustable Extension Assist Mechanism

- Monocentric Knee Joint for Child with Adjustable Extension Mechanism
- Totally Aluminum Body
- 145° Flexion Angle
- Distal Connection: Dia.22mm Tube
- Updated: Flexion & Extension lever has been converted into Heat treated S. Steel.

Code	Material	Weight	Weight Limit
E 81	Aluminum	170 gr	45 kg



E 80

Knee Joints for Children  
Single Axis Knee Joint with Lock

- Monocentric Knee Joint for Child with Lock
- Totally Aluminum Body
- 145° Flexion Angle
- Distal Connection: Dia.22mm Tube

Code	Material	Weight	Weight Limit
E 80	Aluminum	150 gr	45 kg

# Foam Covers





E 65

### Plastozot Foam Cover

- Hard and rigid Plastozot Foam
- 30 mm hole goes through from the foam
- Not pre-shaped. Can be applied to either left or right side

Code	Material	Diameter
E 65	Foam	30 mm



E 66

### AK Foam Cover

- High density AK Foam cover
- Pre-shaped for both left and right options
- Delivered in special vacuumed package
- Height is 85 cm

Code	Side	Material	Lentgh	Calf Diameter
E 66-36	L/R	Foam	85	36 cm
E 66-40	L/R	Foam	85	40 cm
E 66-44	L/R	Foam	85	44 cm
E 66c	L/R	Foam	-	For children

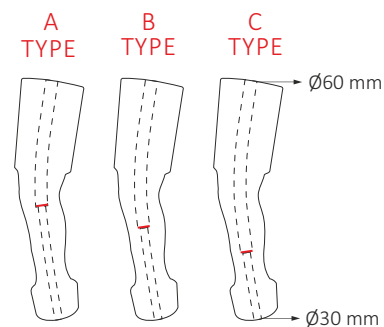

### Order Example

**E 66-40L -B TYPE**



E 69

Pre-Shaped BK Foam Cover

- Left and Right sides available
- 30 mm hole goes through from the foam
- Total height is 48 cm
- Calf circumference around 45 cm

Code	Material	Side	Hole Diameter
E 69-L	Foam	Left	30 mm
E 69-R	Foam	Right	30 mm



E 67

BK Foam Cover

- High density BK Foam Cover
- 30 mm hole goes through from the foam
- Can be applied to the either left or right side
- Height is 50 cm

Code	Material	Diameter
E 67	Foam	30 mm
E 67c	Foam	30 mm



E 68

DK Foam Cover

- High density DK Foam cover
- Left and right pre-shaped
- 30 mm hole goes through from the foam
- Height is 65 cm

Code	Material	Side
E 68-36	Foam	L/R
E 68-40	Foam	L/R
E 68-44	Foam	L/R

Order Example

**E 68-40L**

# Materials





Polyform

- Thermoformable material at 130°
- Suitable for fabricating for Inner socket
- Multiple thickness options are available

Code	Thickness	Size
PO-3	3 mm	1750 x 1100 mm
PO-4	4 mm	1750 x 1100 mm
PO-5	5 mm	1750 x 1100 mm
PO-6	6 mm	1750 x 1100 mm



Plastazote

- Plastazote material for general use
- Three different thickness options are available
- Standard color is Beige. Red, Blue and Pink colors are available upon demand

Code	Thickness	Size
PL-3	3 mm	2000 x 1400 mm
PL-6	6 mm	2000 x 1400 mm
PL-12	12 mm	2000 x 1400 mm



Multicolor EVA Pads

- EVA Pads for general use
- Two different designs are available
- Two thicknesses are available

Code	Thickness	Size
MULTI-A-2	2 mm	1250 x 850 mm
MULTI-A-4	4 mm	1250 x 850 mm
MULTI-B-2	2 mm	1250 x 850 mm
MULTI-B-4	4 mm	1250 x 850 mm

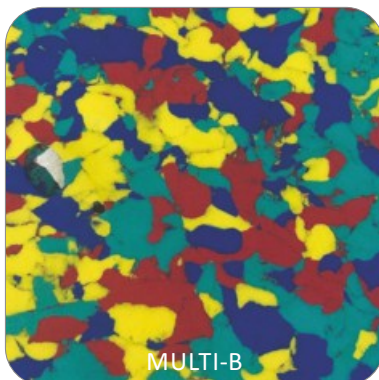



### Polyethylene Plate

- High impact resistance Polyethylene Plate
- Process temperature: ~ 170°
- Hardness: Approx. 60 Shore D
- Heating process: 3 min / mm

Code	Thickness	Size
PE-2	2 mm	2000 x 1000 mm
PE-3	3 mm	2000 x 1000 mm
PE-4	4 mm	2000 x 1000 mm
PE-5	5 mm	2000 x 1000 mm



### Polypropylene Plate

- Polypropylene Plate with excellent formability
- Quite little shrinkage during cooling
- Process temperature: ~ 185°
- Hardness: Approx. 70 Shore D
- Heating process: 3 min / mm

Code	Thickness	Size
PP-2	2 mm	2000 x 1000 mm
PP-3	3 mm	2000 x 1000 mm
PP-4	4 mm	2000 x 1000 mm
PP-5	5 mm	2000 x 1000 mm



### Transparent Check Socket Plate

- Plates made specially for the check (test) sockets
- "Transparent" visual to see through the socket
- Process temperature: ~ 160°
- Hardness: Approx. 80 Shore D
- Heating process: 3 min / mm

Code	Thickness	Size
PT-10	10 mm	400 x 400 mm
PT-12	12 mm	400 x 400 mm
PT-15	15 mm	400 x 400 mm



### FLEX Soft Socket Plate

- Flexible plates specially for soft socket applications
- Very small shrinkage during cooling down
- Hardness: Approx. 40 Shore D
- Process temperature: ~ 160°
- Heating process: 2 min / mm
- 20 Shore D version is available upon demand

Code	Thickness	Size
PF-10	10 mm	400 x 400 mm
PF-12	12 mm	400 x 400 mm
PF-15	15 mm	400 x 400 mm





Carbon Fiber Fabric

Carbon Fiber Fabric

- Twill design for high-strength laminate reinforcements
- Good absorption of lamination resins
- 3K Fabric – 200 g/m<sup>2</sup>

Code	Width	Length
CF-F	1000 mm	2000 mm



Carbon Fiber Thread

Carbon Fiber Roving (Thread) Continuous Filament

- 3K Fabric Thread
- Can be used as attachments
- Can be wrapped on any point requiring extra reinforcement
- Unidirectional

Code	Approx. Weight
CF-R	500 gr



PVA Bag

Ready-Made PVA Bags

- PVA Bags for acrylic and epoxy resin applications
- Transparent color
- Durable and tear-proof
- Each product packing contains 10 pieces

Code	Dimensions A x B x C	Packing Quantity
PVA-10	102 x 10 x 5 cm	10 pieces
PVA-15	102 x 15 x 5 cm	10 pieces
PVA-20	102 x 20 x 5 cm	10 pieces
PVA-25	102 x 25 x 5 cm	10 pieces
PVA-30	102 x 30 x 5 cm	10 pieces
PVA-35	102 x 35 x 5 cm	10 pieces

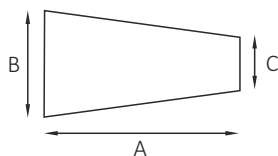

PVA Roll

PVA Roll

- PVA Roll for acrylic and epoxy resin applications
- Transparent color
- Durable and Tear-proof

Code	Width	Length
PVA-ROLL	1000 mm	50 meter



MV-R1

### MOVACRYL – Lamination Resin (Hard)

- Rigid lamination resin with remarkable mechanical properties
- Viscosity approx. 500 mPa.s
- Resin / Hardener ratio. 100 / 2 to 3
- Working Time approx. 30 min.
- 85 Shore D hardness

Code	Material	Package Weight
MV-R1	MOVACRYL Hard	0,9 kg
MV-R5	MOVACRYL Hard	4,6 kg



MV-C1

### MOVACRYL – Carbon Lamination Resin

- Lamination resin for carbon fiber applications
- Viscosity approx. 250 mPa.s
- Resin / Hardener ratio. 100 / 2 to 3
- Working Time approx. 30 min.
- 85 Shore D hardness

Code	Material	Package Weight
MV-C1	MOVACRYL Carbon	0,9 kg
MV-C5	MOVACRYL Carbon	4,6 kg



MV-S1

### MOVACRYL – Sealing Lamination Resin

- Viscosity approx. 300 mPa.s
- Resin / Hardener ratio. 100 / 2 to 3
- Working Time approx. 10 min.
- 85 Shore D hardness

Code	Material	Package Weight
MV-S1	MOVACRYL Sealing	0,9 kg
MV-S5	MOVACRYL Sealing	4,6 kg



MV-F1

### MOVACRYL – Lamination Resin (Soft-Flexible)

- Mixable with MOVACRYL Hard and Carbon resins between 10 – 30 %
- Viscosity approx. 400 mPa.s
- Resin / Hardener ratio. 100 / 2 to 3
- Shore A hardness: 65 to 95

Code	Material	Package Weight
MV-F1	MOVACRYL Flexible	0,9 kg
MV-F5	MOVACRYL Flexible	4,6 kg

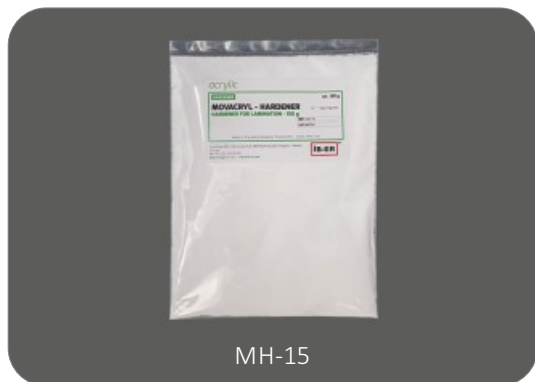

MH-15

### MOVACRYL – Hardener

- Hardener for MOVACRYL resin series. Applicable for all of them.
- This hardener is quite universal for nearly all kind of acrylic resins
- Each pack comes as 150 gr

Code	Material	Package Weight
MH-15	MOVACRYL Hardener	0,15 kg



MP

### MOVpigment

- Coloring agents for MOVACRYL series
- Four different color available
- Each package is 250 gr

Code	Color	Package Weight
MP-SKIN	SKIN	250 gr
MP-BLUE	BLUE	250 gr
MP-BLACK	BLACK	250 gr
MP-RED	RED	250 gr



MF

### MOVFoam and Hardener

- 30 Shore D Hardness Foam
- Perfectly grips onto acrylic sockets
- Expansion start time: 1 min
- End of expansion: 2 min 30 seconds
- Expansion ratio: Approx. 5 times
- Resin / Hardener ratio. 100 / 100
- Density 230 g/L

Code	Material	Package Weight
MF-302	MOVFoam	2 kg
MF-305	MOVFoam	5 kg
MFH-2	Foam Hardener	2 kg
MFH-5	Foam Hardener	5 kg



MF Hardener



M01 Stockinette

### M01 Perlon Stockinette

- General use stockinette for fabricating laminates and reinforcing sockets
- Knitted and finely meshed fabric
- Good stretching properties

Code	Diameter	Packing Weight
M01-4	4 cm	1 Kg
M01-6	6 cm	1 Kg
M01-8	8 cm	1 Kg
M01-10	10 cm	1 Kg
M01-12	12 cm	1 Kg
M01-15	15 cm	1 Kg
M01-20	20 cm	1 Kg



M04 Stockinette

### M04 Nylon Stockinette

- Nylon stockinette for fabricating laminates and reinforcing sockets
- Knitted and finely meshed fabric
- Good stretching properties

Code	Diameter	Packing Weight
M04-4	4 cm	1 Kg
M04-6	6 cm	1 Kg
M04-8	8 cm	1 Kg
M04-10	10 cm	1 Kg
M04-12	12 cm	1 Kg
M04-15	15 cm	1 Kg
M04-20	20 cm	1 Kg



M07 Stockinette

### M07 Cotton Stockinette

- Cotton Stockinette for fabricating laminates and reinforcing sockets
- Knitted and finely meshed fabric
- Good stretching properties

Code	Diameter	Packing Weight
M07-4	4 cm	1 Kg
M07-6	6 cm	1 Kg
M07-8	8 cm	1 Kg
M07-10	10 cm	1 Kg
M07-12	12 cm	1 Kg
M07-15	15 cm	1 Kg
M07-20	20 cm	1 Kg



TF-1



TF-2



TF-3



TF-4



TF-5



### Transfer Papers

- Transfer Papers are decorative films for adding durable patterns to thermoplastic O&P devices.
- They give each device a vivid look and a professional finish.
- The design bonds during forming for a consistent, lasting appearance.
- They support personalization and improve overall patient appeal.

Code	Width	Length
TF-1	150 cm	10 meter
TF-2	150 cm	10 meter
TF-3	150 cm	10 meter
TF-4	150 cm	10 meter
TF-5	150 cm	10 meter



### M02 Stump Sock with Pin hole

- Soft and cushion stump sock with pin hole
- Made by Cotton

Code	Length	Diameter	Material	Packing Quantity
M02-35	35 cm	7 cm	Cotton	24 Pieces
M02-50	50 cm	7 cm	Cotton	24 Pieces
M02-35-BLACK	35 cm	7 cm	Cotton	24 Pieces
M02-50-BLACK	50 cm	7 cm	Cotton	24 Pieces



### M03 Stump Sock

- Soft and cushion stump sock without pin hole
- Made by Cotton

Code	Length	Diameter	Material	Packing Quantity
M03-35	35 cm	7 cm	Cotton	24 Pieces
M03-50	50 cm	7 cm	Cotton	24 Pieces
M03-35-BLACK	35 cm	7 cm	Cotton	24 Pieces
M03-50-BLACK	50 cm	7 cm	Cotton	24 Pieces



### M05 Stump Sock for AK

- Soft and cushion stump sock with and without Pin Hole Options
- Specially produced for AK
- Made by Cotton
- Length is 40 cm, Diameter is 18 cm.

Code	Length	Pin Hole	Packing Quantity
M05-A	40 cm	Yes	24 Pieces
M05-B	40 cm	No	24 Pieces



### M06 Cosmetic Sock

- Beige color, finely meshed fabric
- Durable and high-quality material
- Each pack contains 24 Pieces
- Two length options

Code	Type	Packing Quantity
M06-AK	AK Type	24 Pieces
M06-BK	BK Type	24 Pieces

# Upper Limb Components



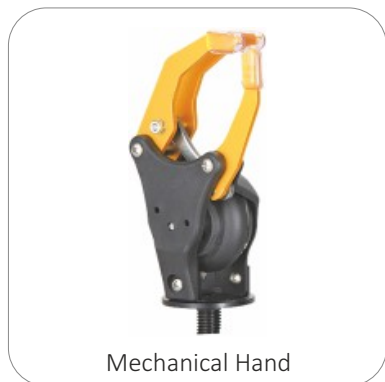

Mechanical Hand

## Mechanical Hand – Voluntary Opening

- Mechanical hand with Outer pull cable
- Connector thread size M12 x 1.5
- Two sizes are available: S – L
- Attention: Size L is compatible with both M and L size Inner hands

Code	Size	Side	Connector
HD1-SL	S Size	Left	M12 x 1.5
HD1-SR	S Size	Right	M12 x 1.5
HD1-LL	L Size	Left	M12 x 1.5
HD1-LR	L Size	Right	M12 x 1.5



Hand Covers

## Inner Hand (Hand Covers for Mechanical Hand)

- Hand covers made by PVC
- Average weight is 145 gr
- Suitable for Outer pull cable exit option
- Three sizes are available

Code	Size	Dimension	Side
HD2-SL	S Size	7 ¼ inch	Left
HD2-SR	S Size	7 ¼ inch	Right
HD2-ML	M Size	7 ¾ inch	Left
HD2-MR	M Size	7 ¾ inch	Right
HD2-LL	L Size	8 inch	Left
HD2-LR	L Size	8 inch	Right



Wrist Connector

## Wrist Connector

- Aluminum body with rubber ring
- Compatible with mechanical hands
- Connector thread size M12 x 1.5
- Two different dimensions are available

Code	Material	Outer Dimension	Weight
HD3-42	Aluminum	42 mm	45 gr
HD3-50	Aluminum	50 mm	50 gr



Modular Elbow Component Kit

- Suitable for Above-Elbow residual limb
- 7 different locking positions
- Connector thread size is M12 x 1.5
- Made by Aluminum body

Code	Side	Weight
HD4-L	Left	310 gr
HD4-R	Right	310 gr



Modular Shoulder Elbow Component Kit

- Suitable for Shoulder Disarticulation
- Passive Elbow lock-7 locking positions
- Connector thread size is M12 x 1.5
- Made by Aluminum body

Code	Side	Weight
HD5-L	Left	375 gr
HD5-R	Right	375 gr



Mechanical Elbow Joint

- Elbow joint with integrated locking mechanism
- Up to 13 different Lock positions
- Upper arm rotation joint
- Distal Diameters ID: 50.2 mm – OD: 55 mm

Code	Material	Weight
HD6	Aluminum Parts / Plastic Shell	355 gr



### Silicone Liners for Upper Extremity

- Made from Medical Grade Silicone Material.
- All of the sizes with Distal Connector
- Textile cover applied for easy donning operation
- Wall thickness approx. 2 mm
- Warranty duration is 3 months

Code	Length	Distal Circumference	Proximal Circumference
SLH-10-12	24 cm	12 cm	15.5 cm
SLH-10-14	26 cm	14 cm	19.5 cm
SLH-10-16	26 cm	16 cm	21 cm
SLH-10-18	30 cm	18 cm	29 cm
SLH-10-20	30 cm	20 cm	34 cm



### Foam Cover for Upper Extremity

- Special carved foam cover for upper extremity
- Inner Hole Diameter is 22 mm
- Length is 48 cm

Code	Material	Color
HD-FOAM	PUR Foam	Beige



## Harness Kits for Upper Extremity

- Basic Harness Kits includes Belts and Attachments
- Compatible for Above-Elbow and Below-Elbow Prosthesis

Code	Description
HD-HARNESS1	Above Elbow Harness Kit
HD-HARNESS2	Below Elbow Harness Kit



# Orthotic Components



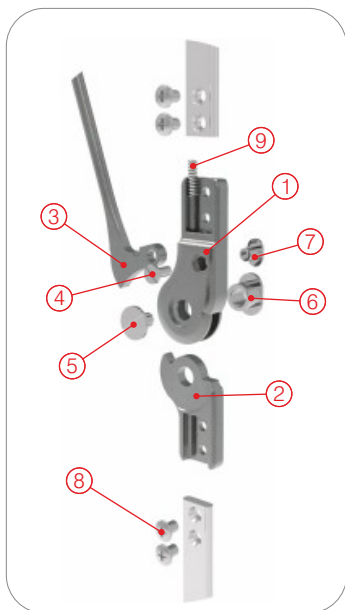

OKJ110

Knee Joint w/ Bale Lock (Springy): Parts

No	Part	Feature	Qty.
1	Upper Section	Stainless Steel	Piece
2	Lower Section	Stainless Steel	Piece
3	Lock Lever	Stainless Steel	Piece
4	Slotted Truss Head Screw	M6 Thread x 8.70mm x Ø14mm	Piece
5	Slotted Truss Head Screw	M4 Thread x 8.70mm x Ø8mm	Piece
6	Bearing Nut	M6 Thread x 8,70mm, Hardened	Piece
7	Bearing Nut	M4 Thread x 8,70mm, Hardened	Piece
8	Phillips Oval Countersunk Head Screw	M5 Thread x 4mm, Ø8mm	Piece
9	Compression Spring	0,5 X 4 X 15 mm	Piece



OKJ110-10

Type-10: Knee Joint w/ Bale Lock

Item	Material	Width	Side	Description	Qty.
OKJ110-10-16R	Stainless Steel	16 mm	Right	Straight & Straight	Pair
OKJ110-10-16L	Stainless Steel	16 mm	Left	Straight & Straight	Pair
OKJ110-10-20R	Stainless Steel	20 mm	Right	Straight & Straight	Pair
OKJ110-10-20L	Stainless Steel	20 mm	Left	Straight & Straight	Pair



OKJ110-20

Type-20: Knee Joint w/ Bale Lock

Item	Material	Width	Side	Description	Qty.
OKJ110-20-16R	Stainless Steel	16 mm	Right	Straight & Contoured	Pair
OKJ110-20-16L	Stainless Steel	16 mm	Left	Straight & Contoured	Pair
OKJ110-20-20R	Stainless Steel	20 mm	Right	Straight & Contoured	Pair
OKJ110-20-20L	Stainless Steel	20 mm	Left	Straight & Contoured	Pair



OKJ110-30

Type-30: Knee Joint w/ Bale Lock

Item	Material	Width	Side	Description	Qty.
OKJ110-30-16R	Stainless Steel	16 mm	Right	Straight & Contoured	Pair
OKJ110-30-16L	Stainless Steel	16 mm	Left	Straight & Contoured	Pair
OKJ110-30-20R	Stainless Steel	20 mm	Right	Straight & Contoured	Pair
OKJ110-30-20L	Stainless Steel	20 mm	Left	Straight & Contoured	Pair

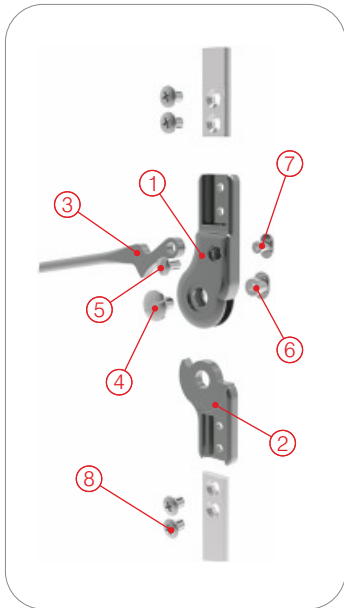

OKJ120

### Knee Joint w/ Bale Lock: Parts

No	Part	Feature	Qty.
1	Upper Section	Stainless Steel	Piece
2	Lower Section	Stainless Steel	Piece
3	Lock Lever	Stainless Steel	Piece
4	Slotted Truss Head Screw	M6 Thread x 8.70mm x Ø14mm	Piece
5	Slotted Truss Head Screw	M4 Thread x 8.70mm x Ø8mm	Piece
6	Bearing Nut	M6 Thread x 8,70mm, Hardened	Piece
7	Bearing Nut	M4 Thread x 8,70 mm, Hardened	Piece
8	Phillips Oval Countersunk Head Screw	M5 Thread x 4 mm x Ø8mm	Piece



OKJ120-10

### Type-10: Knee Joint w/ Bale Lock

Item	Material	Withd	Side	Description	Qty.
OKJ120-10-16R	Stainless Steel	16 mm	Right	Straight & Straight	Pair
OKJ120-10-16L	Stainless Steel	16 mm	Left	Straight & Straight	Pair
OKJ120-10-20R	Stainless Steel	20 mm	Right	Straight & Straight	Pair
OKJ120-10-20L	Stainless Steel	20 mm	Left	Straight & Straight	Pair



OKJ120-20

### Type-20: Knee Joint w/ Bale Lock

Item	Material	Withd	Side	Description	Qty.
OKJ120-20-16R	Stainless Steel	16 mm	Right	Straight & Contoured	Pair
OKJ120-20-16L	Stainless Steel	16 mm	Left	Straight & Contoured	Pair
OKJ120-20-20R	Stainless Steel	20 mm	Right	Straight & Contoured	Pair
OKJ120-20-20L	Stainless Steel	20 mm	Left	Straight & Contoured	Pair



OKJ120-30

### Type-30: Knee Joint w/ Bale Lock

Item	Material	Withd	Side	Description	Qty.
OKJ120-30-16R	Stainless Steel	16 mm	Right	Straight & Contoured	Pair
OKJ120-30-16L	Stainless Steel	16 mm	Left	Straight & Contoured	Pair
OKJ120-30-20R	Stainless Steel	20 mm	Right	Straight & Contoured	Pair
OKJ120-30-20L	Stainless Steel	20 mm	Left	Straight & Contoured	Pair

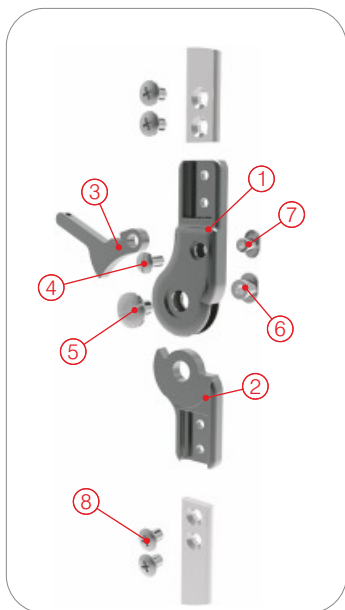

OKJ130

Knee Joint w/ Bale Lock: Parts

No	Part	Feature	Qty.
1	Upper Section	Stainless Steel	Piece
2	Lower Section	Stainless Steel	Piece
3	Lock Lever	Stainless Steel	Piece
4	Slotted Truss Head Screw	M6 Thread x 8.70mm x Ø14mm	Piece
5	Slotted Truss Head Screw	M4 Thread x 8.70mm x Ø8mm	Piece
6	Bearing Nut	M6 Thread x 8,70mm, Hardened	Piece
7	Bearing Nut	M4 Thread x 8,70mm, Hardened	Piece
8	Phillips Oval Countersunk Head Screw	M5 Thread x 4mm x Ø8mm	Piece



OKJ130-10

Type-10: Knee Joint w/ Bale Lock

Item	Material	Width	Side	Description	Qty.
OKJ130-10-16R	Stainless Steel	16 mm	Right	Straight & Straight	Pair
OKJ130-10-16L	Stainless Steel	16 mm	Left	Straight & Straight	Pair
OKJ130-10-20R	Stainless Steel	20 mm	Right	Straight & Straight	Pair
OKJ130-10-20L	Stainless Steel	20 mm	Left	Straight & Straight	Pair



OKJ130-20

Type-20: Knee Joint w/ Bale Lock

Item	Material	Width	Side	Description	Qty.
OKJ130-20-16R	Stainless Steel	16 mm	Right	Straight & Contoured	Pair
OKJ130-20-16L	Stainless Steel	16 mm	Left	Straight & Contoured	Pair
OKJ130-20-20R	Stainless Steel	20 mm	Right	Straight & Contoured	Pair
OKJ130-20-20L	Stainless Steel	20 mm	Left	Straight & Contoured	Pair



OKJ130-30

Type-30: Knee Joint w/ Bale Lock

Item	Material	Width	Side	Description	Qty.
OKJ130-30-16R	Stainless Steel	16 mm	Right	Straight & Contoured	Pair
OKJ130-30-16L	Stainless Steel	16 mm	Left	Straight & Contoured	Pair
OKJ130-30-20R	Stainless Steel	20 mm	Right	Straight & Contoured	Pair
OKJ130-30-20L	Stainless Steel	20 mm	Left	Straight & Contoured	Pair

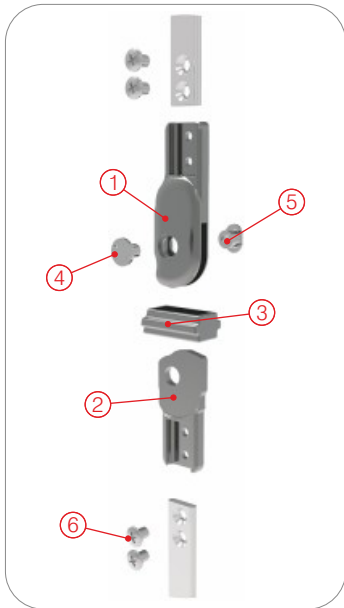

OKJ140

### Knee Joint w/Ring Lock: Parts

No	Part	Feature	Qty.
1	Upper Section	Stainless Steel	Piece
2	Lower Section	Stainless Steel	Piece
3	Ring	Stainless Steel	Piece
4	Two Hole Screw	M6 Thread x 7.30mm x Ø12mm	Piece
5	Bearing Nut	M6 Thread x 7.30mm, Hardened	Piece
6	Phillips Oval Countersunk Head Screw	M5 Thread x 4 mm x Ø8mm	Piece



OKJ140-10

### Type-10: Knee Joint w/ Ring Lock

Item	Material	Width	Side	Description	Qty.
OKJ140-10-16R	Stainless Steel	16 mm	Right	Straight & Straight	Pair
OKJ140-10-16L	Stainless Steel	16 mm	Left	Straight & Straight	Pair
OKJ140-10-20R	Stainless Steel	20 mm	Right	Straight & Straight	Pair
OKJ140-10-20L	Stainless Steel	20 mm	Left	Straight & Straight	Pair



OKJ140-20

### Type-20: Knee Joint w/ Ring Lock

Item	Material	Width	Side	Description	Qty.
OKJ140-20-16R	Stainless Steel	16 mm	Right	Straight & Contoured	Pair
OKJ140-20-16L	Stainless Steel	16 mm	Left	Straight & Contoured	Pair
OKJ140-20-20R	Stainless Steel	20 mm	Right	Straight & Contoured	Pair
OKJ140-20-20L	Stainless Steel	20 mm	Left	Straight & Contoured	Pair



OKJ140-30

### Type-30: Knee Joint w/ Ring Lock

Item	Material	Width	Side	Description	Qty.
OKJ140-30-16R	Stainless Steel	16 mm	Right	Straight & Contoured	Pair
OKJ140-30-16L	Stainless Steel	16 mm	Left	Straight & Contoured	Pair
OKJ140-30-20R	Stainless Steel	20 mm	Right	Straight & Contoured	Pair
OKJ140-30-20L	Stainless Steel	20 mm	Left	Straight & Contoured	Pair

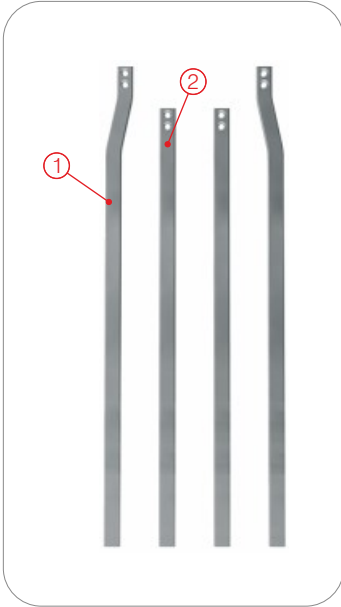

OLB110

Lateral Bar Set

No	Part	Feature	Qty.
1	Lower Side Bar	410mm length, 4mm thickness	Piece
2	Upper Side Bar	450mm length, 4mm thickness	Piece

Item	Material	Width	Qty.
OLB110-16	Stainless Steel	16 mm	Set
OLB110-20	Stainless Steel	20 mm	Set
OLB110-16AL	Aluminum	16 mm	Set
OLB110-20AL	Aluminum	20 mm	Set

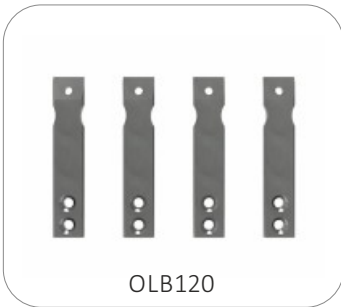

OLB120

Side Bar Set for Carbon Orthosis

Item	Material	Width	Feature	Qty.
OLB120-16	Stainless Steel	16 mm	80mm length, 4mm thickness	Set
OLB120-20	Stainless Steel	20 mm	80mm length, 4mm thickness	Set

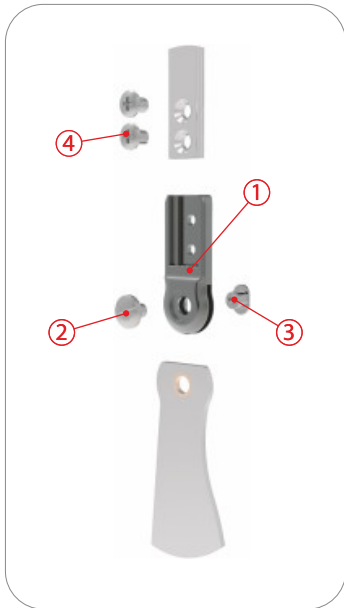

OAJ110

Ankle Joint: Parts

No	Part	Feature	Qty.
1	Joint	Stainless Steel	Piece
2	Slotted Truss Head Screw	M5 Thread x 6.50 mm x Ø12 mm (for 16mm) M6 Thread x 7.30 mm x Ø14 mm (for 20mm)	Piece
3	Bearing Nut	M5 Thread x 6.50 mm, Hardened (for 16mm) M6 Thread x 7.30 mm, Hardened (for 20mm)	Piece
4	Phillips Oval Countersunk Head Screw	M5 Thread x 4 mm x Ø8 mm	Piece



OAJ110-10

Type-10 | Ankle Joint

Item	Material	Width	Side	Description	Qty.
OAJ110-10-16R	Stainless Steel	16 mm	Right	Straight & Straight	Pair
OAJ110-10-16L	Stainless Steel	16 mm	Left	Straight & Straight	Pair
OAJ110-10-20R	Stainless Steel	20 mm	Right	Straight & Straight	Pair
OAJ110-10-20L	Stainless Steel	20 mm	Left	Straight & Straight	Pair



OAJ110-20

Type-20 | Ankle Joint

Item	Material	Width	Side	Description	Qty.
OAJ110-20-16R	Stainless Steel	16 mm	Right	Straight & Contoured	Pair
OAJ110-20-16L	Stainless Steel	16 mm	Left	Straight & Contoured	Pair
OAJ110-20-20R	Stainless Steel	20 mm	Right	Straight & Contoured	Pair
OAJ110-20-20L	Stainless Steel	20 mm	Left	Straight & Contoured	Pair



OAJ110-30

Type-30 | Ankle Joint

Item	Material	Width	Side	Description	Qty.
OAJ110-30-16R	Stainless Steel	16 mm	Right	Straight & Contoured	Pair
OAJ110-30-16L	Stainless Steel	16 mm	Left	Straight & Contoured	Pair
OAJ110-30-20R	Stainless Steel	20 mm	Right	Straight & Contoured	Pair
OAJ110-30-20L	Stainless Steel	20 mm	Left	Straight & Contoured	Pair



OAJ130

Foot Stirrup

Item	Material	Length from Center	Thickness	Qty.
OAJ130-16	Stainless Steel	63 mm	2.5mm	Set
OAJ130-20	Stainless Steel	63 mm	3mm	Set



OAJ120

Item	Material	Length from Center	Thickness	Qty.
OAJ120-16	Stainless Steel	145 mm	2.5mm	Set
OAJ120-20	Stainless Steel	160 mm	3mm	Set



HJ-100

HJ-200

Hip Joints

Code	Material	Weight	Wideness	Weight Limit
HJ-100	Stainless Steel	162 gr	32mm	125kg
HJ-200	Stainless Steel	128 gr	25mm	100kg

# Notes



A series of horizontal dotted lines spanning the width of the page, intended for taking notes.



A series of horizontal dotted lines for writing notes, spanning the width of the page.

**iB-ER**®

**PROSTHETIC**

*make your life easier*



...to be continued...



İB-ER MAKİNA A.Ş.  
2006 sok. No:13/1 Turgutlu OSB.  
Turgutlu - Manisa / TÜRKİYE

Phone: +90(236) 312 32 00  
Fax: +90(236) 312 32 06  
info@ib-er.com  
www.ib-er.com